

Middletown, Rhode Island
Washville Car Wash

April 2022

TRAFFIC IMPACT STUDY



Washville Car Wash
Middletown, Rhode Island

TRAFFIC IMPACT STUDY

Prepared by: BETA GROUP, INC.

Prepared for: Mr. Nicholas A. Giacobbi
Director of Development
TPG Companies
1140 Reservoir Avenue
Cranston, Rhode Island 02920

April 2022

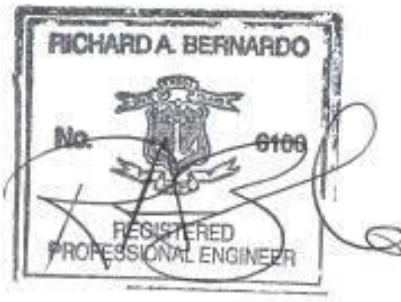



April 29, 2022

Mr. Nicholas A. Giacobbi
Director of Development
TPG Companies
1140 Reservoir Avenue
Cranston, Rhode Island 02920

Re: Proposed Commercial Redevelopment
Washville Car Wash
A.P. 106 Lots 115 & 116
Middletown, Rhode Island 02842

Dear Mr. Giacobbi:

BETA Group, Inc., in accordance with our scope of services, has completed a traffic impact study for a proposed commercial redevelopment project in the Town of Middletown, Rhode Island. The site is located on the easterly side of West Main Road (Route 114) between Access Road and Forest Avenue. The property is defined by Assessor's Plat 106, Lots 115 & 116 which together contains approximately 0.87 acres of land.

Based upon information provided by your office, and a review of the current site plan prepared by Sevan Engineering, it is our understanding that the redevelopment project, Washville Car Wash, will include construction of a new 4,201 square foot building to accommodate a single bay automated car wash and an associated parking area for 19 vehicles, 15 of which contain vacuum stations. Access and egress to the site will be provided from two driveways, an entrance only, and exit only curb opening on West Main Road (Route 114).

The study included herein, was conducted to determine the adequacy of the existing servicing roadways to accommodate anticipated traffic to be generated by the commercial redevelopment project. An analysis of potential impacts to the roadway capacity and safety has been completed and is discussed in the following report.

Very truly yours,
BETA Group, Inc.

A handwritten signature in black ink that reads 'Paul J. Bannon'.

Paul J. Bannon
Associate

BETA GROUP, INC.
701 George Washington Highway, Lincoln, RI 02865
P: 401.333.2382 | F: 401.333.9225 | W: www.BETA-Inc.com

TABLE OF CONTENTS

1.0 Introduction 1

2.0 Project Area..... 3

3.0 Existing Conditions..... 3

 3.1 Roadways..... 3

 3.2 Intersections..... 5

 3.3 Traffic Flow Data 5

4.0 Safety Analysis..... 6

5.0 Impact Analysis..... 9

 5.1 Trip Generation 9

 5.2 Future Traffic Volumes 11

 5.3 Operational Analysis..... 11

6.0 Conclusions and Recommendations..... 15

APPENDICES

- Appendix A: Traffic Volume Data
- Appendix B: Traffic Crash Data
- Appendix C: Trip Generation
- Appendix D: Operational Analysis

LIST OF TABLES

TABLE 1 – Trip Generation Estimate..... 9

TABLE 2 – Highway Capacity Manual Criteria..... 13

TABLE 3 – Level of Service Summary (Existing Conditions) 13

TABLE 4 – Level of Service Summary (Future Conditions) 14

LIST OF FIGURES

FIGURE 1 – Project Vicinity Map 2

FIGURE 2 – Project Location Map..... 4

FIGURE 3 – Existing Traffic Volumes..... 7

FIGURE 4 – Site Layout and Access Plan 10

FIGURE 5 – Future Traffic Volumes 12

1.0 INTRODUCTION

The objective of the following study is to assess the potential traffic impacts associated with a proposed commercial redevelopment project in the Town of Middletown. The property is situated on a parcel of land on the easterly side of West Main Road between Access Road to the south and Forest Avenue to the north. Refer to the Figure 1, Project Vicinity Map, on the following page for the project location within the community.

The redevelopment proposal will consist of the construction of a 4,201 square foot building to accommodate a single bay automated car wash on vacant lots that had recently contained two single family homes. Parking will be available for 19 vehicles with 15 dedicated to vacuum stations. Access will be provided from two, one-way curb cuts on West Main Road approximately 160 feet apart, similar to the adjacent abutting properties.

The study summarized herein focused on both traffic flow efficiency and safety along West Main Road (Route 114) in the immediate vicinity of the subject property, and at the proposed driveways. The impacts associated with the site related traffic have been defined and evaluated in accordance with standard traffic engineering guidelines and procedures.

The traffic engineering study completed for this project included the following:

- A traffic counting program to define the existing traffic patterns and operational characteristics along the servicing roadway including West Main Road. The data collection included a manual turning movement count (TMC) at the West Main Road signalized intersection with Access Road/East Bay Village and review of record counts from a previous study completed by our office.
- An inventory of the physical roadway characteristics of West Main Road in the project area to determine the adequacy of the existing roadway geometric features in reference to safety and operations.
- An analysis of crash records obtained from the Middletown Police Department to define potential safety issues along the immediate segment of West Main Road adjacent to the site.
- An estimate of future traffic volumes for the proposed commercial development was calculated using data from the "Trip Generation" Manual, an informational report published by the Institute of Transportation Engineers (ITE).
- Evaluation and analysis of the traffic safety and operational issues for existing and future traffic conditions.
- Development of recommendations for improvements where necessary, that would be required to maintain safe and efficient traffic flow in the project area.

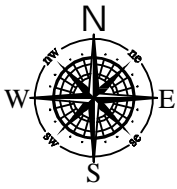

Washville Car Wash

MIDDLETOWN, RHODE ISLAND

Figure 1 - Project Vicinity Map



2.0 PROJECT AREA

As noted in the previous section, the subject property is situated on the easterly side of West Main Road just north of Access Road. The property is currently vacant but had previously been developed with two single-family homes, which were recently razed to allow redevelopment of the property to a commercial use consistent with the current zoning of this section of West Main Road. Figure 2 on the following page depicts the general project area, and the boundary lines of the subject property.

Land use along the West Main Road (Route 114) corridor in the immediate project area can be defined as predominantly commercial in nature with residential neighborhoods located off of intersecting side streets. Immediately abutting the property to the north and south are small commercial plazas. To the east is the East Bay Village apartment complex. To the west on the opposite side of West Main Road, is the Newport Corporate Park, an office complex with multiple buildings and a single driveway off of Access Road.

Further north and south along West Main Road, the properties contain small to large scale commercial buildings and shopping centers with restaurants, retail stores, professional offices, car dealerships, and banks. In addition, the Naval Station Newport is located west of the site along Access Road. Multiple US Naval buildings including military housing, a shipyard, and gate access to the main naval station are located along Access Road.

West Main Road (Route 114) will serve as the primary access route to the redeveloped property. Based upon the operating characteristics along the roadway adjacent to the site, and the estimated volume and type of traffic associated with the commercial redevelopment, a study impact area was defined for the project. The limits of our analysis focused on West Main Road (Route 114) between Access Road and Forest Avenue, with a primary focus on the site access driveways and the signalized junction of West Main Road with Access Road/East Bay Village due to its immediate proximity to the site.

3.0 EXISTING CONDITIONS

3.1 ROADWAYS

West Main Road (Route 114)

West Main Road (Route 114) is a north/south urban principal arterial running between Route 24 to the north and East Main Road (Route 138) to the south. West Main Road provides immediate local access to abutting properties but also links to higher order facilities including Route 24 to the north. In the project area abutting the property, West Main Road is approximately 50 feet wide consisting of two 11-foot travel lanes and a 1-foot shoulder in each direction, separated by a 4-foot wide striped median.

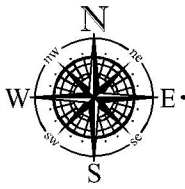

Washville Car Wash

MIDDLETOWN, RHODE ISLAND

Figure 2 - Project Area Map

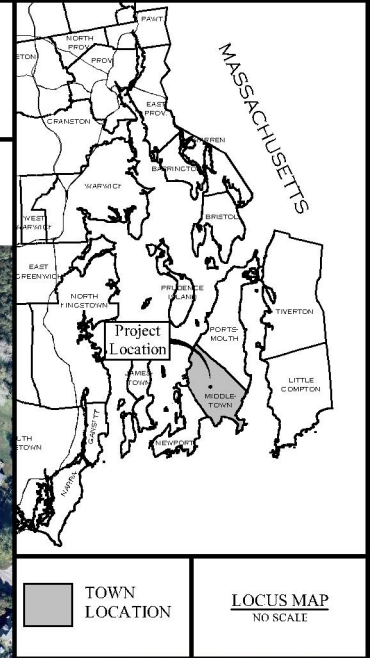

The pavement surface can be classified as being in fair condition with visible minor rutting and longitudinal cracking. Concrete curbing and sidewalks are provided on both sides of West Main Road. Cobra-head light fixtures are located sporadically along the corridor on utility poles for nighttime illumination of the roadway.



The speed limit is posted at 30 MPH in the site vicinity. The adjacent photograph depicts the typical characteristics of West Main Road looking north with the subject property on the right.

3.2 INTERSECTIONS

West Main Road (Route 114) at Access Road/East Bay Village Access Driveway

Access Road and the East Bay Village driveway intersect West Main Road to form a signalized four-way junction. The West Main Road northbound and southbound approaches consist of a separate left turn lane, a thru lane, and shared thru/right turn lane. The Access Road eastbound approach provides a separate left turn lane and a shared thru/right turn lane. The East Bay Village driveway westbound approach provides a single multi-purpose lane.

The intersection was determined to operate in a fully actuated mode consisting of three phases. West Main Road movements are serviced in two phases including protected northbound and southbound left turn movements, followed by through/right concurrent movements. The Access Road and East Bay Village access driveway approaches are serviced concurrently under a single permitted phase. In addition, pedestrian accommodations are provided on the west and south legs of the intersection including marked pedestrian crosswalks, pedestrian signal heads with push buttons. The pedestrian phases run concurrent with the appropriate, non-conflicting traffic phases.

3.3 TRAFFIC FLOW DATA

Existing traffic flow characteristics for this area were developed from a traffic counting program completed by BETA and from record traffic data available from a previous traffic study completed by BETA. The data collection included a Manual Turning Movement Count (TMC) at the signalized intersection of West Main Road with Access Road/East Bay Village access driveway during the weekday afternoon and Saturday midday peak periods between 4:00 to 6:00 PM and 11:30 AM to 1:30 PM, respectively, in April 2022. In addition, record TMC at the signalized intersection of West Main Road

with Access Road/East Bay Village driveway were obtained from a previous study completed by BETA in June 2018.

It is important to note that although COVID-19-related restrictions have been lifted in Rhode Island since the end of May 2021, the traffic data specifically collected as part of this study was compared to record data to ensure volumes are fully representative of typical traffic conditions experienced along West Main Road. As such, the April 2022 TMC data obtained for this project was reviewed against the record June 2018 TMC data to determine the variation in traffic volumes along West Main Road. Based on a comparison of the TMC data at the study intersection of West Main Road with Access Road/East Bay Village access driveway during the afternoon peak period, the traffic volume data collected in June 2018 was found to have higher overall existing traffic volumes.

Therefore, for this study, the traffic data collected in June 2018 has been utilized as a basis of analysis. In addition, the Saturday midday peak period TMC volumes collected as part of BETA's data collection in April 2022 were adjusted accordingly to reflect the June 2018 overall higher volumes at the study intersection. Also, BETA reviewed the RIDOT seasonal adjustment factors and determined that urban principal arterial in the month of June typically experience higher than average daily traffic volumes during the weekday. To be conservative in the analysis, June 2018 traffic volumes were not reduced to reflect average traffic conditions.

Based upon the record turning movement data as defined, West Main Road along the property frontage services approximately 2,730 vehicles during the weekday afternoon peak hour between 4:00 and 5:00 PM with approximately 1,590 vehicles northbound and 1,140 vehicles southbound. During the Saturday midday peak hour between 12:00 and 1:00 PM, West Main Road serviced 2,950 vehicles with approximately 1,530 vehicles northbound and 1,420 vehicles southbound. Figure 3 on the following page depicts the daily peak hour turning movement volumes at the study intersection. Complete count information can be found in the Appendix.

4.0 SAFETY ANALYSIS

To determine if there are any limiting factors affecting safety relating to access to the proposed commercial project, the physical characteristics of West Main Road (Route 114) in the project area, and specifically at the proposed site driveway locations were investigated. These limiting factors would potentially include horizontal or vertical alignment changes or roadside obstructions that limit sight distances for vehicles traveling along the road or entering the road from a side street or driveway location. In this instance, the sight distance standard is necessary to permit turning vehicles to safely enter and exit the site driveways.

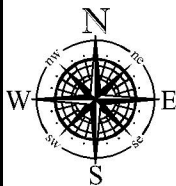

Washville Car Wash

MIDDLETOWN, RHODE ISLAND

Figure 3 - Existing Traffic Volumes



1 WEST MAIN ROAD (ROUTE 14)/ACCESS ROAD/EAST BAY VILLAGE

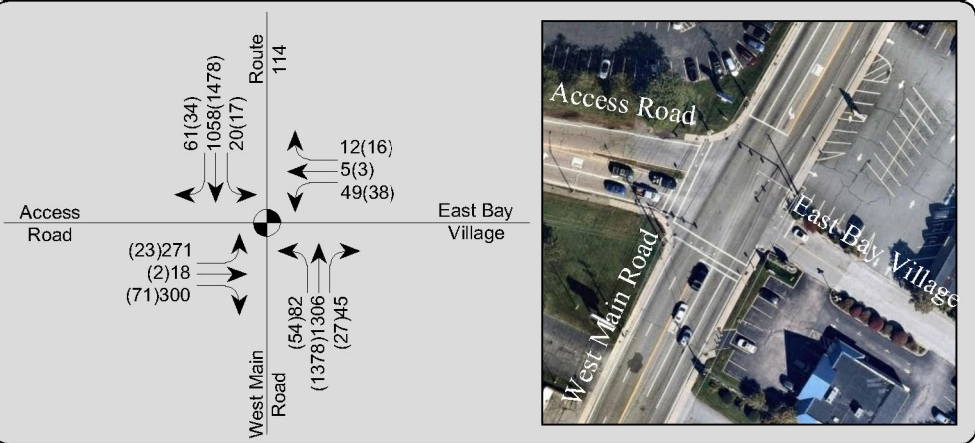

LEGEND:

- TURN LANE
- XXX WEEKDAY PM PEAK VOLUMES (4:00 TO 5:00)
- (XXX) SATURDAY MD PEAK VOLUMES (12:00 TO 1:00)
- STUDY INTERSECTION
- TRAFFIC SIGNAL

The horizontal and vertical alignment of West Main Road in the project area can be described as relatively straight and generally level. Based upon the existing roadway geometry as described, the available sight distance at the proposed southernmost driveway location on West Main Road, which will be restricted to an enter only driveway, is greater than 500 feet through the signalized intersection with Access Road to the south as it relates to left turn entering traffic. In addition, the available sight distances at the proposed northernmost driveway location, which will be restricted to an exit only driveway on West Main Road, are greater than 500 feet to the north and south. These values are in excess of AASHTO's recommended minimum sight distance of 200 feet based on the posted speed limit of 30 mph and the 305 feet for the observed travel speeds ranging from 30 to 40 mph along this section of West Main Road. It should be noted that speeds are highly variable due to the signal-controlled Access Road and Forest Avenue junctions, where vehicles are turning off of or onto West Main Road at a low speed or slowing to the stop line at the traffic signals.

As a result of the preliminary evaluation of the existing roadway geometry and physical features, it does not appear that any significant physical roadway safety deficiencies exist within the defined study area. Also, as part of our analysis, a review of crash statistics was completed. Data was reviewed from the Middletown Police Department for the latest full three-year period from January 2017 to December 2019 to determine if any location in the project area experienced a high frequency or pattern of crashes. The 2020 and 2021 data were not requested due to the atypical roadway conditions during both years.

A total of 75 crashes (avg. 25 per year) occurred in the project area over the three-year study period, with twelve involving injuries. Summarizing the data, 37 of the crashes, with four involving injuries, occurred at the signalized intersection of West Main Road with Forest Avenue; 27 of the crashes, with eight involving injuries, occurred at the signalized intersection of West Main Road with Access Road; and 11 of the crashes, with no reported injuries, occurred along the section of West Main Road between Forest Avenue and Access Road. Forty-four of the intersection crashes were rear-end crashes, ten were sideswipe collisions (same direction), seven were angle crashes, one was a head-on collision, one was an errant vehicle colliding with multiple vehicles, and one involved a person on a motorized scooter on a marked crosswalk.

This is typical of signalized junctions where the majority of the crashes are rear end collisions due to the numerous starting and stopping movements required for the signal change intervals. The side-swipe collisions were attributed to vehicles changing lanes to avoid turning vehicles while approaching the intersections. The majority of the angle crashes at intersections were attributed to drivers not yielding the right-of-way and two were attributed to running a red light.

In addition, eleven crashes that occurred along West Main Street between Forest Avenue and Access Road were seven rear-end collisions, two were sideswipe (same direction) collisions, and two were angle collisions. Both the angle collisions involved vehicles exiting the *Shell Gas Station* driveway just south of Forest Avenue. The driveway crashes at *Shell Gas Station* can be attributed to the proximity of the driveway to the Forest Avenue traffic signal and requirement of entering/exiting traffic to turn through the northbound vehicle queue on West Main Road.

Based upon the historical crash data obtained from the local police, and a review of existing roadway geometry and operations, roadway or traffic related safety improvements could be investigated to improve safety at the signalized intersections. The RIDOT could review the clearance intervals to determine if they require adjustment in an effort to reduce the number of rear-end collisions. In addition, future design consideration by the RIDOT for the corridor, consistent with the Aquidneck Island Transportation Study final report, dated July 2011, prepared by Vanasse Hangen Brustlin, which includes providing left turn lanes at key intersections including at the intersection with Forest Avenue to mitigate crashes is planned as part of the state's long-term improvements to West Main Road in the area. A summary of the crash data depicting the number, type, and severity is provided in the Appendix.

5.0 IMPACT ANALYSIS

5.1 TRIP GENERATION

To determine the traffic impact of a proposed development, estimates of anticipated traffic to be generated by a particular land use must be calculated. As previously discussed, the redevelopment proposal consists of the construction of a 4,201 square foot building to accommodate a single bay automated car wash. Access and egress are proposed from two one-way driveways on West Main Road with one restricted to enter only and the other an exit only. Figure 4 on the following page depicts the site layout and access plan, prepared by Sevan Engineering.

For this site, projected traffic volumes for the commercial project were based on use of trip generation factors. These factors are taken from the "Trip Generation" manual, an informational report published by the Institute of Transportation Engineers (ITE), a national professional organization for traffic and transportation engineers. The data provided in the ITE report are based on extensive traffic studies for various types of land uses (residential, commercial, industrial, etc.). This data has been found to be very reliable and provides a sound basis for estimating future trips to new developments. For the proposed commercial redevelopment project, Land Use Code 948 Automated Car Wash was reviewed for applicability in developing an estimate of site related vehicle trips. The appropriate worksheets from the manual are included in the Appendix along with the trip estimate calculations. Table 1 below summarizes the estimate trip volumes calculated for this project.

TABLE 1 – Trip Generation Estimate

		Enter	Exit	Total
<u>Description</u>				
<u>Weekday PM Peak Hour</u>				
ITE Land Use Code 948	Automated Car Wash	30	30	60
<u>Saturday MD Peak Hour</u>				
ITE Land Use Code 948	Automated Car Wash	64	64	128

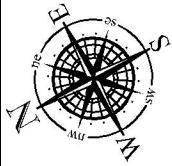

Washville Car Wash

MIDDLETOWN, RHODE ISLAND

Figure 4 - Site Layout

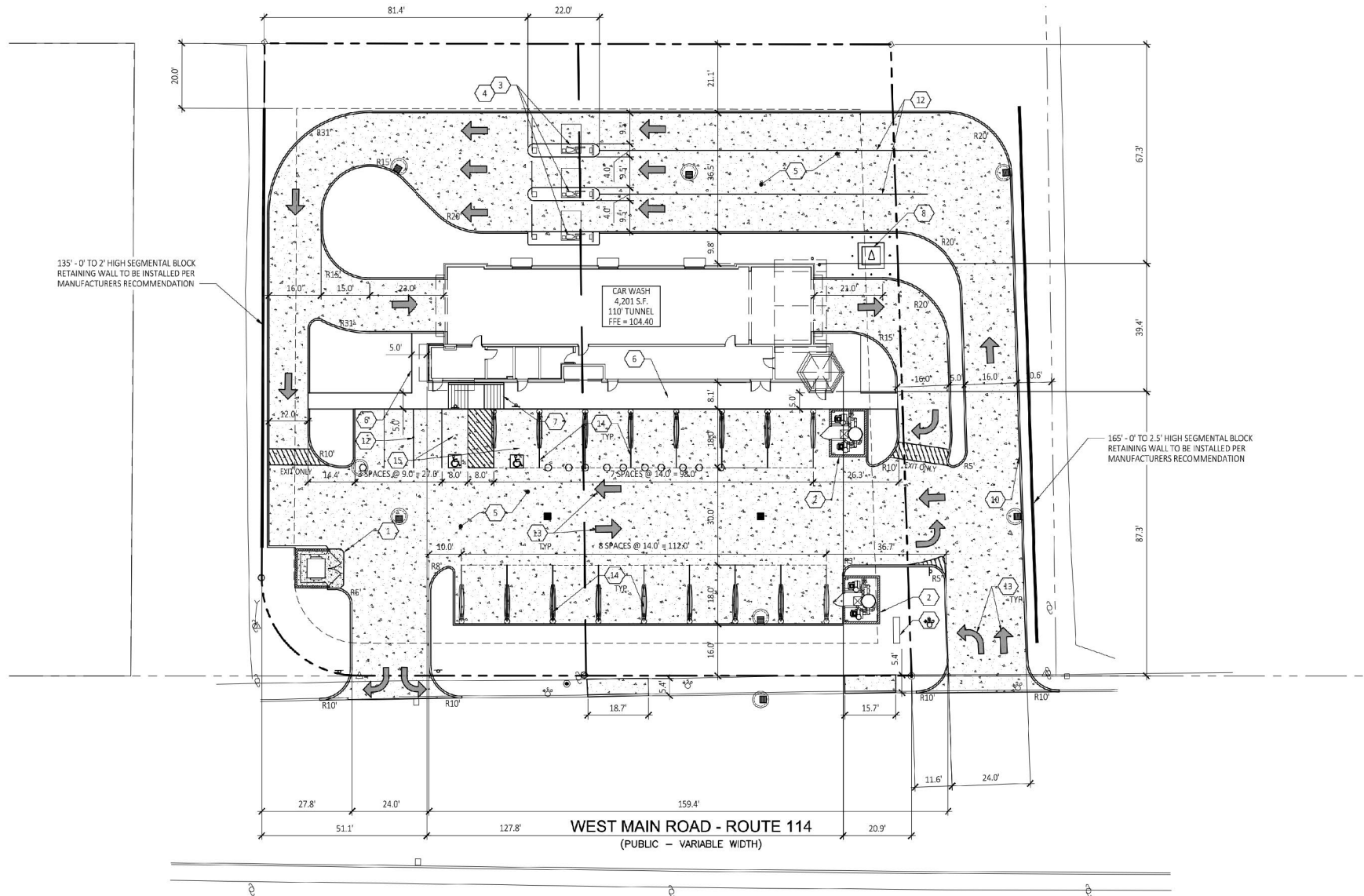

5.2 FUTURE TRAFFIC VOLUMES

In order to properly assess the impacts of a development, future traffic conditions of area roadways should be estimated for the period when the development is constructed and fully occupied. Typically, the expansion of base traffic is calculated when a project is to be constructed over an extended period (+3 to 5 years). In all instances, area growth that may affect capacity results should be considered. For this project, a conservative annual growth rate of 1.5 percent was utilized for the future background traffic growth based on the Aquidneck Island Transportation Study final report, dated July 2011. This rate was applied to the existing volumes to establish a future 2025 Build traffic condition at the study intersections. The future 2025 Build condition included traffic generated by the new commercial development. Figure 5 on the following page depicts the estimated future traffic volumes at the study intersections. Site distribution figures are also provided in the Appendix for reference.

In developing the intersection volumes to be analyzed under build conditions, a directional distribution of the site traffic was estimated. The distribution was based on current traffic patterns in the area and the proposed land use including the presence of similar land use in the surrounding area. It is estimated that 50% of the site traffic will arrive from and depart the north and 50% will arrive from and depart to the south during both the weekday afternoon and Saturday midday peak hours.

5.3 OPERATIONAL ANALYSIS

The key to any traffic impact analysis is the evaluation of roadway operations during peak traffic periods on the servicing roadway system. This situation would occur when the site-generated traffic, combined with the traffic volumes on the main roadway, result in the highest one-hour volume serviced along a roadway segment, or through an intersection. Review of record traffic data along the servicing roadway and operational data of the car wash business found that the weekday PM and Saturday MD peak hours would represent this worst-case combination of site-generated traffic with the servicing roadway peak traffic period.

The Highway Capacity Manual, 6th Edition, methodology provides the most accurate means of evaluating traffic capacity and delays for roadways and intersections. The results of this procedure are expressed in terms of Level of Service (LOS). Level of Service is a qualitative measure of traffic flow efficiency based on anticipated vehicle delays. For example, LOS "A" represents the best condition with little or no delay, while LOS "F" indicates that the roadway/intersection is at full capacity resulting in extended vehicle delays and potential queuing. Table 2 on page 13 outlines the Level of Service delay criteria presented in the Highway Capacity Manual for signalized and unsignalized intersections.

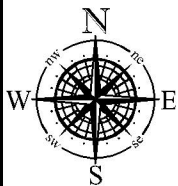

Washville Car Wash

MIDDLETOWN, RHODE ISLAND

Figure 5 - Future Traffic Volumes



1 WEST MAIN ROAD (ROUTE 14)/ACCESS ROAD/EAST BAY VILLAGE

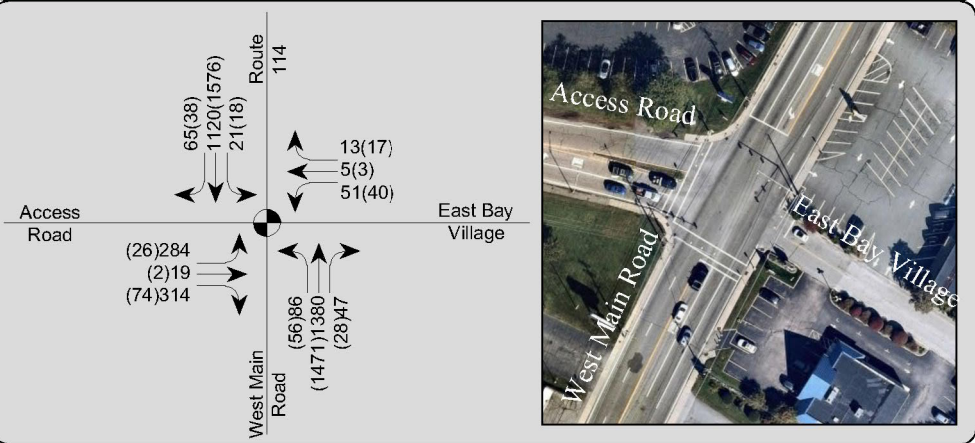

2 WEST MAIN ROAD (ROUTE 14)/SITE DRIVEWAYS

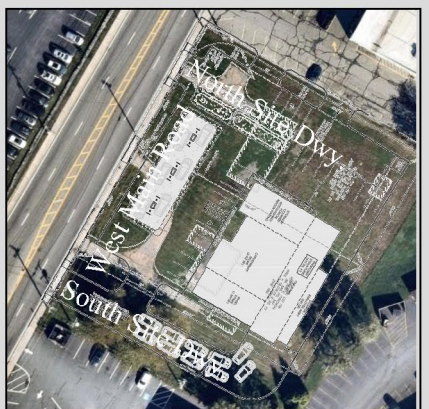
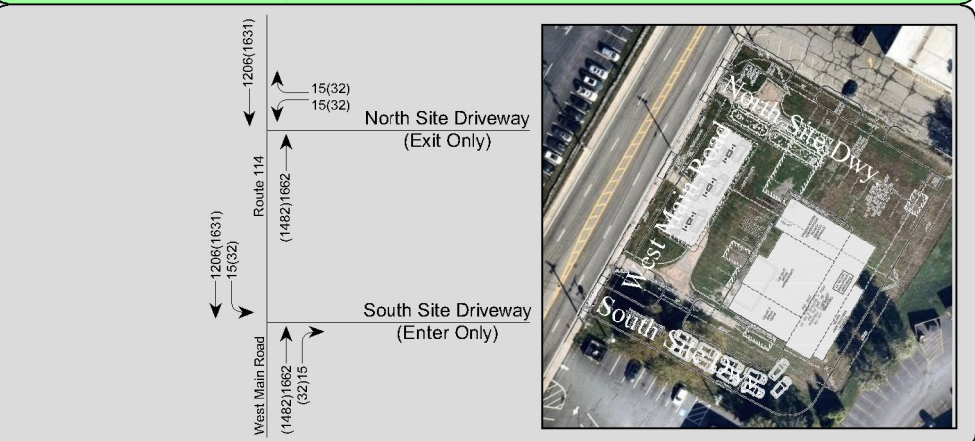

LEGEND:

- ↘ TURN LANE
- XXX WEEKDAY PM PEAK VOLUMES (4:00 TO 5:00)
- (XXX) SATURDAY MD PEAK VOLUMES (12:00 TO 1:00)
- ① STUDY INTERSECTION
- ⊙ TRAFFIC SIGNAL

TABLE 2 – Highway Capacity Manual Criteria

Level of Service	Unsignalized Delay Per Vehicle (sec)	Signalized Delay Per Vehicle (sec)
A	<10	<10
B	>10 and <15	>10 and <20
C	>15 and <25	>20 and <35
D	>25 and <35	>35 and <55
E	>35 and <50	>55 and <80
F	>50	>80

The West Main Road (Route 114) intersections with Access Road/East Bay Village and the site driveways were analyzed for the weekday afternoon and Saturday midday peak hours. The capacity analysis worksheets are included in the Appendix and Tables 3 and 4 summarize the results of the existing and future build conditions analyses.

TABLE 3 – Level of Service Summary (Existing Conditions)

Location / Movement	EXISTING CONDITIONS							
	Weekday PM Peak Hour				Saturday MD Peak Hour			
	LOS	Delay	95 th % Queue Length (veh.)	v/c	LOS	Delay	95 th % Queue Length (veh.)	v/c
West Main Road (Route 114) at Access Road/East Bay Village (S)								
W. Main Rd. NB Left	D	48.4	4	0.50	D	44.4	3	0.35
W. Main Rd. NB Thru/Right	C	20.9	22	0.76	A	20.8	22	0.77
W. Main Rd. SB Left	D	41.8	2	0.16	D	41.4	2	0.14
W. Main Rd. SB Thru/Right	C	25.3	16	0.77	B	43.8	26	0.98
Access Rd. EB Left	D	37.9	10	0.69	C	23.3	2	0.05
Access Rd. EB Thru/Right	A	9.7	5	0.51	A	7.2	2	0.14
East Bay Village WB	C	22.5	3	0.22	B	19.1	3	0.13
OVERALL	C	23.5	-	-	C	32.1	-	-

(S) – Signalized

(U) – Unsignalized

As can be seen in Table 3, under the existing conditions, the signalized intersection operates overall at an acceptable Level of Service (LOS) LOS C during both the weekday PM and Saturday MD peak periods with critical movements experiencing LOS D or better.

TABLE 4 – Level of Service Summary (Future Conditions)

Location / Movement	FUTURE 2025 BUILD CONDITIONS							
	Weekday PM Peak Hour				Saturday MD Peak Hour*			
	LOS	Delay	95 th % Queue Length (veh.)	v/c	LOS	Delay	95 th % Queue Length (veh.)	v/c
East Main Road (Route 138) at Aquidneck Avenue (Route 138A)/Commercial Driveway (S)								
W. Main Rd. NB Left	D	49.4	4	0.53	D	46.9	3	0.39
W. Main Rd. NB Thru/Right	C	22.6	24	0.81	B	10.4	16	0.65
W. Main Rd. SB Left	D	41.8	2	0.17	D	41.4	2	0.14
W. Main Rd. SB Thru/Right	C	27.0	17	0.81	B	16.9	18	0.79
Access Rd. EB Left	D	40.1	11	0.72	C	34.8	2	0.12
Access Rd. EB Thru/Right	B	11.1	5	0.53	B	11.2	2	0.25
East Bay Village WB	C	23.0	3	0.25	C	29.8	3	0.27
OVERALL	C	25.3	-	-	B	14.9	-	-
West Main Road (Route 114) at South Site Driveway (U)								
W. Main Rd. SB Left	A	1.3	1	0.04	A	1.9	1	0.07
West Main Road (Route 114) at North Site Driveway (U)								
Site Dwy. WB Left	F	274.3	2	0.63	F	584.8	5	1.45
Site Dwy. WB Right	C	18.4	1	0.06	C	17.2	1	0.11

(S) – Signalized, (U) – Unsignalized, * – Optimized Timing (Saturday MD Peak Only)

Table 4 presents the future conditions at the study intersections where the analysis found that the estimated increase in traffic during the peak periods resulting from the proposed site development project, combined with the base traffic growth along the servicing roadways will not adversely impact overall traffic operations along West Main Road, specifically at the defined study intersection reviewed for this project.

The signalized intersection of West Main Road with Access Road/East Bay Village will continue to operate overall at an acceptable LOS C during the future weekday PM peak hour and can improve overall from an acceptable LOS C to LOS B with signal optimization during the future Saturday midday peak hour with critical movements experiencing LOS D or better similar to existing conditions. The traffic signal timing was optimized to show the potential improvement that could be realized at this intersection with minor timing adjustments for the weekend condition.

The estimated volume of left turning traffic from West Main Road (Route 114) at the south site driveway location was determined to operate at efficiently at LOS A during both the future weekday afternoon and Saturday MD peak hours. The north site driveway approach, which is restricted to exit only, is expected to operate efficiently for right turn exiting vehicles with typically only one to two vehicles waiting to exit at any one time during both the future weekday afternoon and Saturday MD peak hours. The movement that will experience greater delays are the left turning exiting movement at the north

site driveway where delays have been estimated to be in excess of 50 seconds during peak traffic periods.

One condition that does have a positive impact on the available gaps in traffic are the adjacent signalized intersections at Access Road/East Bay Village to the south and Forest Avenue to the north. The traffic signals help create gaps in West Main Road (Route 114) traffic during the change intervals that driveway and side street traffic can utilize to access the main road. The positive effect of the adjacent signals cannot be adequately modeled into the HCS analysis. Field observations found that the average queue for this movement on the adjacent plaza to the north was one vehicle, resulting in no congestion and acceptable operations at the plaza driveway, which can be expected at the proposed north site exit only driveway. To increase capacity and reduce delays, the north site exit only driveway has been designed with separate left and right turn exiting lanes so right turning traffic can operate more efficiently with less delay as seen in the table.

The unsignalized capacity analysis results indicating prolonged minor approach delays is consistent with most unsignalized driveway or side street intersections along the corridor. Any amount of driveway traffic would yield the delay results found in our study due to the high main street volumes and limitations of the unsignalized analysis. Of concern is whether the driveway has the on-site stacking distance to accommodate potential queuing based upon the volume, and that favorable intersection geometry exists. In this instance, both concerns are satisfied in addition to the previously mentioned signalization factor, which promotes sufficient gaps to yield better operations than the analysis indicates. It is anticipated that the driveway will operate with acceptable delays and average queuing of one to two vehicles resulting in no driveway congestion and acceptable delays.

6.0 CONCLUSIONS AND RECOMMENDATIONS

In summary, the study has shown that the proposed commercial project access has been designed to provide a level of traffic safety and efficiency on the servicing roadway system. The safety of the proposed access driveways on West Main Road (Route 114) were reviewed for geometry and sight distances. The proposed driveway intersections were determined to provide sufficient sight distances in accordance with AASHTO criteria for visibility and decision making of drivers attempting to enter/exit main street traffic from the proposed driveways.

The results of the operational analysis indicate that the estimated increase in traffic during the peak periods resulting from the proposed commercial project will have a minor effect on overall traffic operations along West Main Road (Route 114), particularly during the weekday afternoon and Saturday midday peak hours when the site services its greatest daily volumes.

Therefore, based upon the data collected on the servicing roadways, the analysis completed as part of this study, along with the access design proposed, the Washville Car Wash land development was determined to have adequate and safe access to a public street, and will not have an adverse impact on public safety and welfare in the study area.

APPENDIX

- A. Traffic Volume Data
- B. Traffic Crash Data
- C. Trip Generation
- D. Operational Analysis

APPENDIX A – Traffic Volume Data

Intersection Turning Movement Count

West Main Road (Route 114) at Access Road/East Bay Village

A

Intersection Turning Movement Count

West Main Road (Route 114) at Access Road/East Bay Village

West Main Road (Route 114) at Access Road/East Bay Village

BETA Group, Inc.

701 George Washington Highway
 Lincoln, Rhode Island 02865
 P: 401.333.2382 | W: www.BETA-inc.com

Project: Washville Car Wash
 Town/City: Middletown, RI
 Location: W. Main Rd. at Access Rd.
 Weather: 50's/Overcast

File Name : route 114 at access road_pm peak period
 Site Code : 04262022
 Start Date : 4/26/2022
 Page No : 2

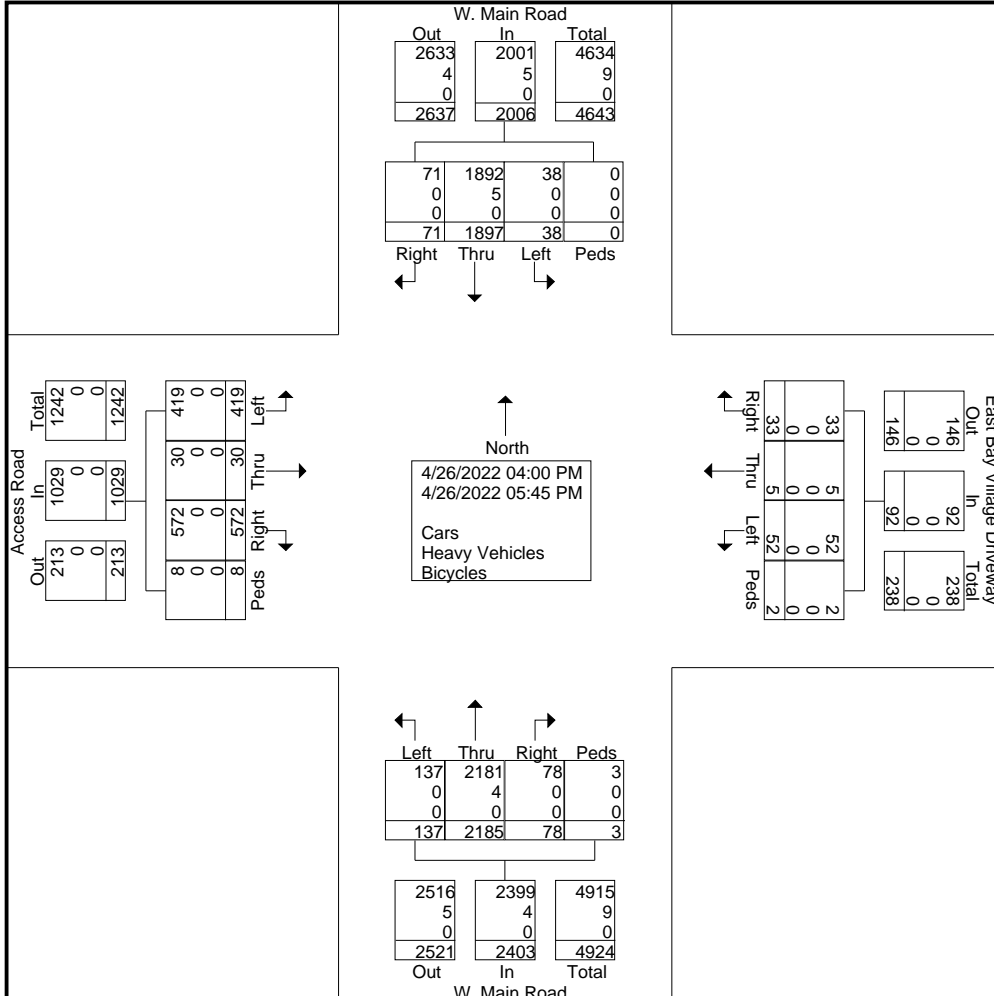

BETA Group, Inc.

701 George Washington Highway
Lincoln, Rhode Island 02865

P: 401.333.2382 | W: www.BETA-inc.com

Project: Washville Car Wash
Town/City: Middletown, RI
Location: W. Main Rd. at Access Rd.
Weather: 50's/Overcast

File Name : route 114 at access road_pm peak period
Site Code : 04262022
Start Date : 4/26/2022
Page No : 3

Start Time	W. Main Road Southbound					East Bay Village Driveway Westbound					W. Main Road Northbound					Access Road Eastbound					Int. Total	
	Right	Thru	Left	Peds	App. Total	Right	Thru	Left	Peds	App. Total	Right	Thru	Left	Peds	App. Total	Right	Thru	Left	Peds	App. Total		
Peak Hour Analysis From 04:00 PM to 05:45 PM - Peak 1 of 1																						
Peak Hour for Entire Intersection Begins at 04:15 PM																						
04:15 PM	6	234	3	0	243	3	3	4	2	12	12	279	21	0	312	87	1	59	1	148	715	
04:30 PM	11	243	6	0	260	2	0	7	0	9	8	274	18	0	300	79	7	56	2	144	713	
04:45 PM	14	243	5	0	262	5	0	8	0	13	10	296	24	0	330	91	7	60	2	160	765	
05:00 PM	7	247	3	0	257	4	1	9	0	14	10	273	14	0	297	75	4	55	1	135	703	
Total Volume	38	967	17	0	1022	14	4	28	2	48	40	1122	77	0	1239	332	19	230	6	587	2896	
% App. Total	3.7	94.6	1.7	0		29.2	8.3	58.3	4.2		3.2	90.6	6.2	0		56.6	3.2	39.2	1			
PHF	.679	.979	.708	.000	.975	.700	.333	.778	.250	.857	.833	.948	.802	.000	.939	.912	.679	.958	.750	.917	.946	
Cars	38	964	17	0	1019	14	4	28	2	48	40	1119	77	0	1236	332	19	230	6	587	2890	
% Cars	100	99.7	100	0	99.7	100	100	100	100	100	100	99.7	100	0	99.8	100	100	100	100	100	99.8	
Heavy Vehicles	0	3	0	0	3	0	0	0	0	0	0	3	0	0	3	0	0	0	0	0	0	6
% Heavy Vehicles	0	0.3	0	0	0.3	0	0	0	0	0	0	0.3	0	0	0.2	0	0	0	0	0	0	0.2
Bicycles	0	0	0	0	0	0	0	0	0	0	0	0	0	0	0	0	0	0	0	0	0	0
% Bicycles	0	0	0	0	0	0	0	0	0	0	0	0	0	0	0	0	0	0	0	0	0	0

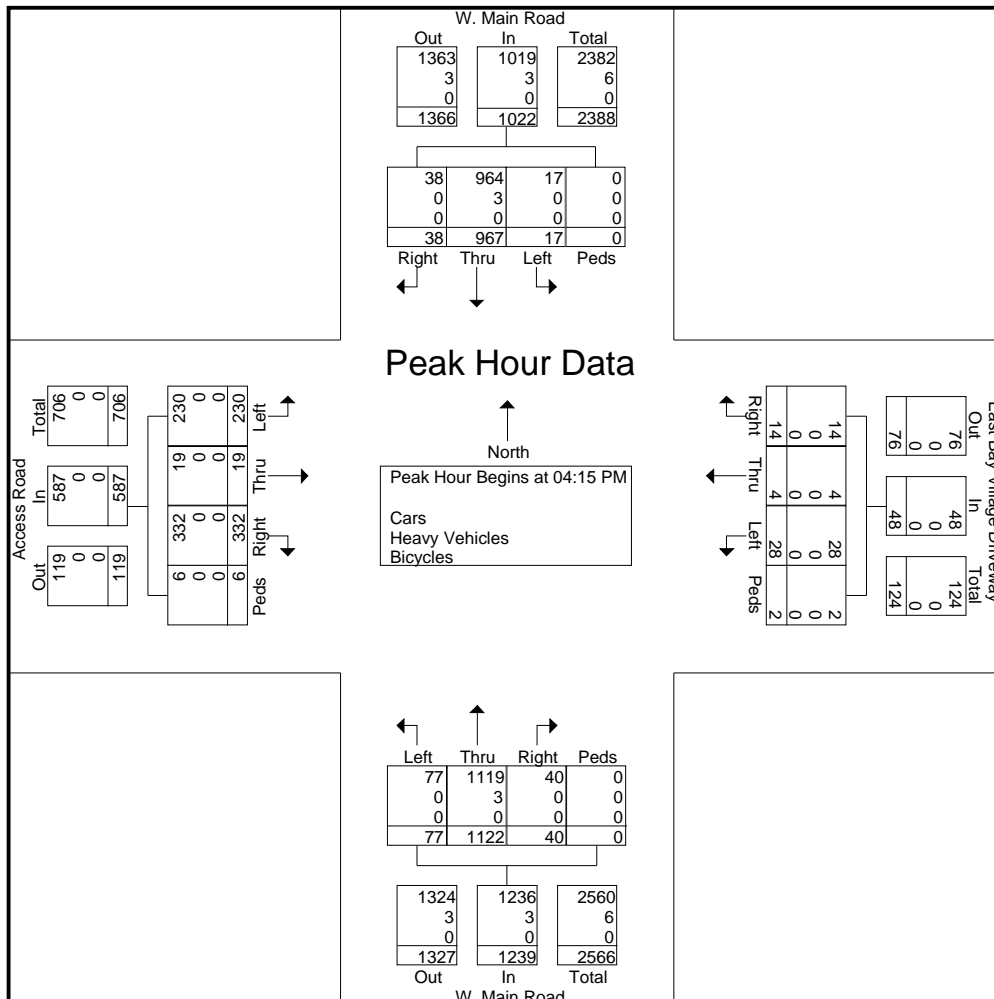

BETA Group, Inc.

701 George Washington Highway
 Lincoln, Rhode Island 02865
 P: 401.333.2382 | W: www.BETA-inc.com

Project: Washville Car Wash
 Town/City: Middletown, RI
 Location: W. Main Rd. at Access Rd.
 Weather: 60s/Sunny

File Name : W. Main at Access_Sat. MD Peak Period
 Site Code : 1043202
 Start Date : 4/30/2022
 Page No : 2

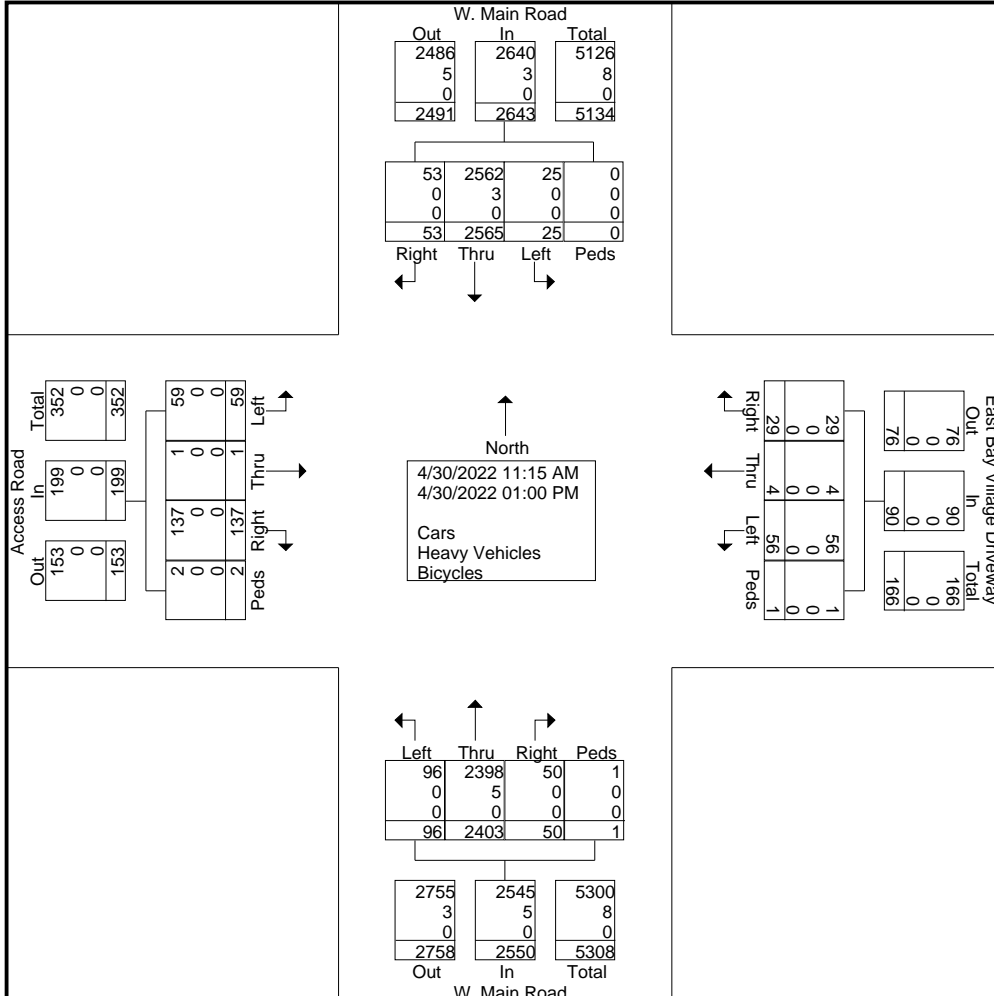

BETA Group, Inc.

701 George Washington Highway
 Lincoln, Rhode Island 02865
 P: 401.333.2382 | W: www.BETA-inc.com

Project: Washville Car Wash
 Town/City: Middletown, RI
 Location: W. Main Rd. at Access Rd.
 Weather: 60s/Sunny

File Name : W. Main at Access_Sat. MD Peak Period
 Site Code : 1043202
 Start Date : 4/30/2022
 Page No : 3

Start Time	W. Main Road Southbound					East Bay Village Driveway Westbound					W. Main Road Northbound					Access Road Eastbound					Int. Total
	Right	Thru	Left	Peds	App. Total	Right	Thru	Left	Peds	App. Total	Right	Thru	Left	Peds	App. Total	Right	Thru	Left	Peds	App. Total	
Peak Hour Analysis From 11:15 AM to 01:00 PM - Peak 1 of 1																					
Peak Hour for Entire Intersection Begins at 12:00 PM																					
12:00 PM	5	300	3	0	308	3	0	12	0	15	6	328	13	0	347	16	0	7	0	23	693
12:15 PM	8	354	4	0	366	4	0	8	0	12	8	301	11	0	320	14	0	4	1	19	717
12:30 PM	9	324	4	0	337	6	0	6	0	12	6	296	16	1	319	12	0	3	1	16	684
12:45 PM	8	345	4	0	357	1	2	8	0	11	4	308	8	0	320	21	1	6	0	28	716
Total Volume	30	1323	15	0	1368	14	2	34	0	50	24	1233	48	1	1306	63	1	20	2	86	2810
% App. Total	2.2	96.7	1.1	0		28	4	68	0		1.8	94.4	3.7	0.1		73.3	1.2	23.3	2.3		
PHF	.833	.934	.938	.000	.934	.583	.250	.708	.000	.833	.750	.940	.750	.250	.941	.750	.250	.714	.500	.768	.980
Cars	30	1323	15	0	1368	14	2	34	0	50	24	1232	48	1	1305	63	1	20	2	86	2809
% Cars	100	100	100	0	100	100	100	100	0	100	100	99.9	100	100	99.9	100	100	100	100	100	100.0
Heavy Vehicles	0	0	0	0	0	0	0	0	0	0	0	1	0	0	1	0	0	0	0	0	1
% Heavy Vehicles	0	0	0	0	0	0	0	0	0	0	0	0.1	0	0	0.1	0	0	0	0	0	0.0
Bicycles	0	0	0	0	0	0	0	0	0	0	0	0	0	0	0	0	0	0	0	0	0
% Bicycles	0	0	0	0	0	0	0	0	0	0	0	0	0	0	0	0	0	0	0	0	0

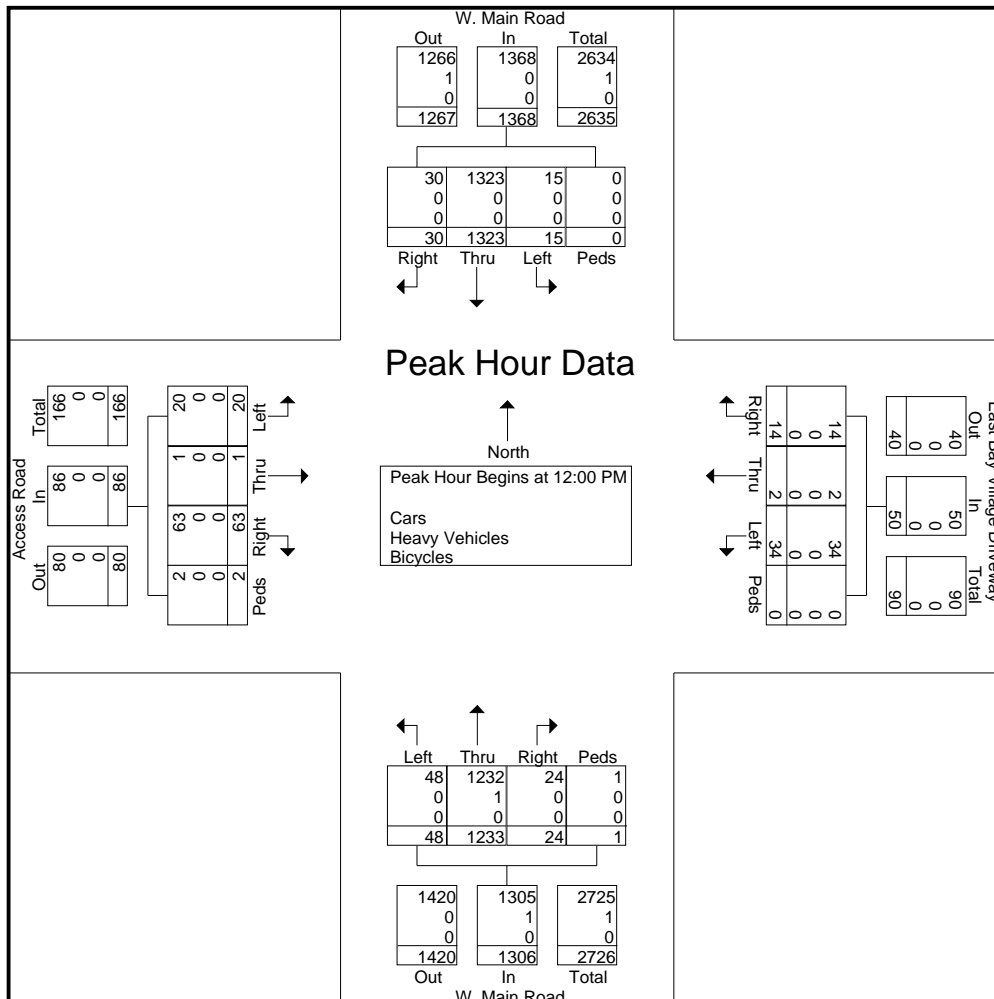

West Main Road (Route 114) at Access Road/East Bay Village

(Source; Ultra Sonic Car Wash and Gas Station Traffic Impact Study Report, dated August 2018
(Revised December 2019) by BETA Group)



www.BETA-inc.com

6 Blackstone Valley Place
Lincoln, RI 02865

Project: Proposed Commercial Development
Town/City: Middletown, RI
Int.: W. Main Rd. at Access Rd.
Weather: Mostly Sunny/60's

File Name : West Main TMC
Site Code : 00603901
Start Date : 6/6/2018
Page No : 1

Groups Printed- Vehicles

Start Time	W. Main Road Southbound					East Bay Village Westbound					W. Main Road Northbound					Access Road Eastbound					Int. Total
	Left	Thru	Right	Peds	App. Total	Left	Thru	Right	Peds	App. Total	Left	Thru	Right	Peds	App. Total	Left	Thru	Right	Peds	App. Total	
07:00 AM	0	243	101	0	344	8	10	9	0	27	87	174	1	0	262	8	0	26	0	34	667
07:15 AM	0	238	93	0	331	4	6	4	0	14	95	202	2	0	299	13	1	23	0	37	681
07:30 AM	2	258	89	0	349	7	8	5	0	20	80	207	5	0	292	15	0	20	0	35	696
07:45 AM	4	287	65	0	356	10	3	5	0	18	84	210	3	0	297	10	0	14	0	24	695
Total	6	1026	348	0	1380	29	27	23	0	79	346	793	11	0	1150	46	1	83	0	130	2739
08:00 AM	4	276	59	0	339	8	4	4	0	16	82	178	7	2	269	9	1	25	0	35	659
08:15 AM	3	286	60	0	349	10	2	5	0	17	74	192	5	0	271	16	2	33	1	52	689
08:30 AM	3	282	51	0	336	14	6	5	0	25	66	208	3	1	278	14	2	22	0	38	677
08:45 AM	4	305	41	0	350	9	3	1	0	13	54	217	6	0	277	13	1	17	0	31	671
Total	14	1149	211	0	1374	41	15	15	0	71	276	795	21	3	1095	52	6	97	1	156	2696
*** BREAK ***																					
03:45 PM	2	271	7	0	280	8	0	3	1	12	19	339	12	1	371	56	6	71	1	134	797
Total	2	271	7	0	280	8	0	3	1	12	19	339	12	1	371	56	6	71	1	134	797
04:00 PM	7	254	8	0	269	12	1	4	1	18	21	347	16	0	384	73	10	100	0	183	854
04:15 PM	2	259	23	0	284	13	2	2	3	20	16	273	8	0	297	64	4	67	1	136	737
04:30 PM	8	275	11	0	294	13	2	3	0	18	18	332	9	0	359	66	0	63	1	130	801
04:45 PM	3	270	19	0	292	11	0	3	1	15	27	354	12	0	393	68	4	70	1	143	843
Total	20	1058	61	0	1139	49	5	12	5	71	82	1306	45	0	1433	271	18	300	3	592	3235
05:00 PM	7	298	9	0	314	10	2	5	1	18	17	367	16	1	401	48	2	54	0	104	837
05:15 PM	3	265	7	0	275	6	2	3	0	11	24	315	11	0	350	43	3	48	0	94	730
05:30 PM	2	303	10	0	315	11	0	5	0	16	13	266	11	0	290	41	3	34	8	86	707
Grand Total	54	4370	653	0	5077	154	51	66	7	278	777	4181	127	5	5090	557	39	687	13	1296	11741
Apprch %	1.1	86.1	12.9	0		55.4	18.3	23.7	2.5		15.3	82.1	2.5	0.1		43	3	53	1		
Total %	0.5	37.2	5.6	0	43.2	1.3	0.4	0.6	0.1	2.4	6.6	35.6	1.1	0	43.4	4.7	0.3	5.9	0.1	11	



www.BETA-inc.com

6 Blackstone Valley Place
Lincoln, RI 02865

Project: Proposed Commercial Development
Town/City: Middletown, RI
Int.: W. Main Rd. at Access Rd.
Weather: Mostly Sunny/60's

File Name : West Main TMC
Site Code : 00603901
Start Date : 6/6/2018
Page No : 2

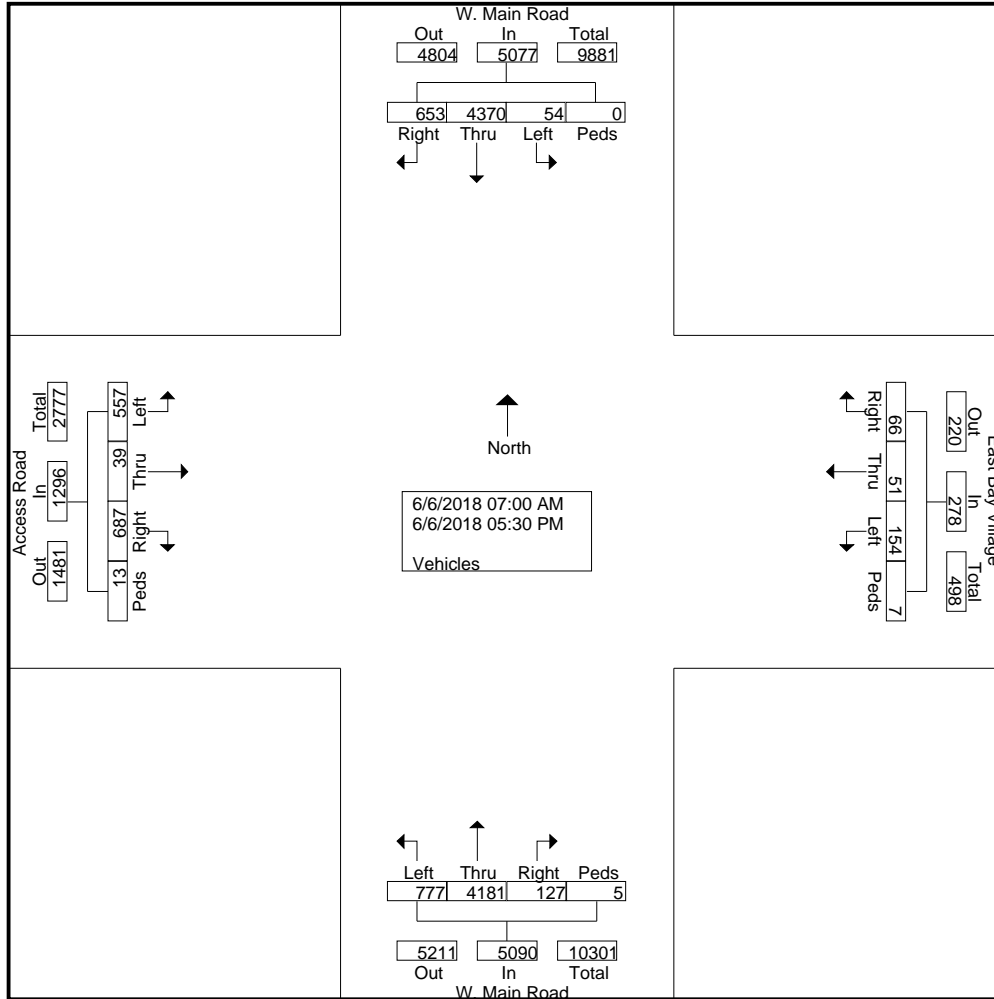



www.BETA-inc.com

6 Blackstone Valley Place
Lincoln, RI 02865

Project: Proposed Commercial Development
Town/City: Middletown, RI
Int.: W. Main Rd. at Access Rd.
Weather: Mostly Sunny/60's

File Name : West Main TMC
Site Code : 00603901
Start Date : 6/6/2018
Page No : 3

Start Time	W. Main Road Southbound					East Bay Village Westbound					W. Main Road Northbound					Access Road Eastbound					Int. Total
	Left	Thru	Right	Peds	App. Total	Left	Thru	Right	Peds	App. Total	Left	Thru	Right	Peds	App. Total	Left	Thru	Right	Peds	App. Total	
Peak Hour Analysis From 07:00 AM to 11:45 AM - Peak 1 of 1																					
Peak Hour for Entire Intersection Begins at 07:00 AM																					
07:00 AM	0	243	101	0	344	8	10	9	0	27	87	174	1	0	262	8	0	26	0	34	667
07:15 AM	0	238	93	0	331	4	6	4	0	14	95	202	2	0	299	13	1	23	0	37	681
07:30 AM	2	258	89	0	349	7	8	5	0	20	80	207	5	0	292	15	0	20	0	35	696
07:45 AM	4	287	65	0	356	10	3	5	0	18	84	210	3	0	297	10	0	14	0	24	695
Total Volume	6	1026	348	0	1380	29	27	23	0	79	346	793	11	0	1150	46	1	83	0	130	2739
% App. Total																					
PHF	.375	.894	.861	.000	.969	.725	.675	.639	.000	.731	.911	.944	.550	.000	.962	.767	.250	.798	.000	.878	.984

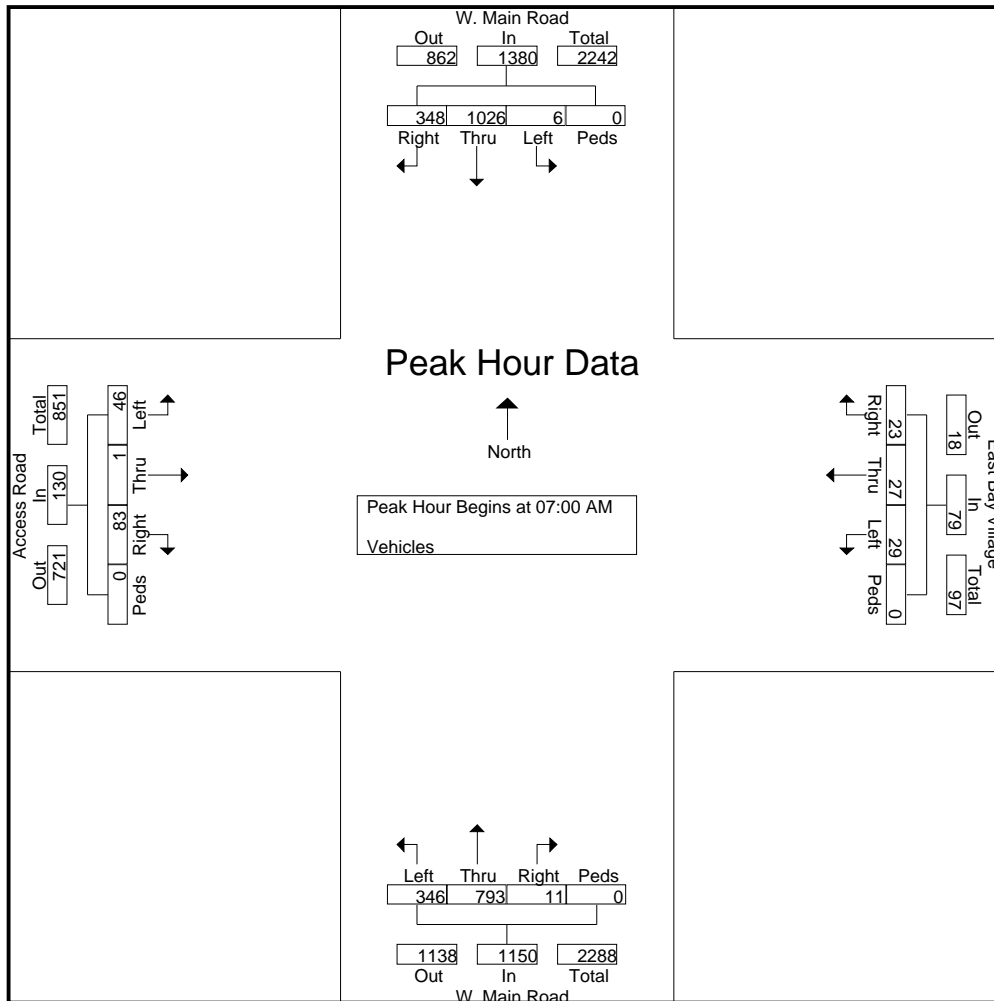



www.BETA-inc.com

6 Blackstone Valley Place
Lincoln, RI 02865

Project: Proposed Commercial Development
Town/City: Middletown, RI
Int.: W. Main Rd. at Access Rd.
Weather: Mostly Sunny/60's

File Name : West Main TMC
Site Code : 00603901
Start Date : 6/6/2018
Page No : 4

Start Time	W. Main Road Southbound					East Bay Village Westbound					W. Main Road Northbound					Access Road Eastbound					Int. Total
	Left	Thru	Right	Peds	App. Total	Left	Thru	Right	Peds	App. Total	Left	Thru	Right	Peds	App. Total	Left	Thru	Right	Peds	App. Total	
Peak Hour Analysis From 12:00 PM to 05:30 PM - Peak 1 of 1																					
Peak Hour for Entire Intersection Begins at 04:00 PM																					
04:00 PM	7	254	8	0	269	12	1	4	1	18	21	347	16	0	384	73	10	100	0	183	854
04:15 PM	2	259	23	0	284	13	2	2	3	20	16	273	8	0	297	64	4	67	1	136	737
04:30 PM	8	275	11	0	294	13	2	3	0	18	18	332	9	0	359	66	0	63	1	130	801
04:45 PM	3	270	19	0	292	11	0	3	1	15	27	354	12	0	393	68	4	70	1	143	843
Total Volume	20	1058	61	0	1139	49	5	12	5	71	82	1306	45	0	1433	271	18	300	3	592	3235
% App. Total																					
PHF	.625	.962	.663	.000	.969	.942	.625	.750	.417	.888	.759	.922	.703	.000	.912	.928	.450	.750	.750	.809	.947

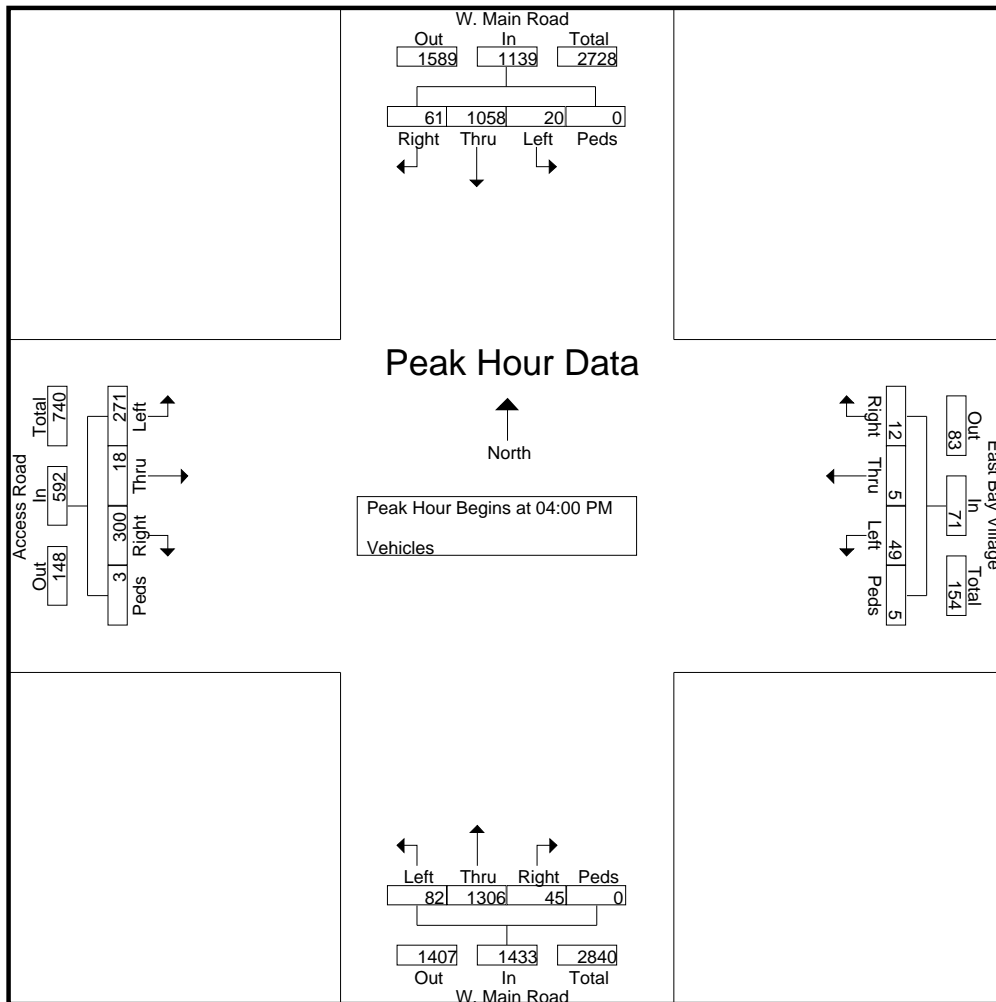

APPENDIX B – Traffic Crash Data

January 2017 through December 2019

West Main Road (Route 114) – Access Road to Forest Avenue

Crash Data Summary

	Year			Total	Average per Year
	2017	2018	2019		
Intersection					
West Main Road (Route 114) at Forest Avenue	14	12	11	37	12
West Main Road (Route 114) at Access Road	11	7	9	27	9
Segment					
West Main Road (Route 114) - Forest Avenue to Access Road	5	2	4	11	4
Total	30	21	24	75	25

West Main Road at Forest Avenue

	2017	2018	2019	Total	Percent
Collision Type					
Rear End	13	6	6	25	68%
Angle	1	3	1	5	14%
Head-On	0	0	0	0	0%
Sideswipe, Same Direction	0	3	4	7	19%
Sideswipe, Opposite Direction	0	0	0	0	0%
Rear-to-Side	0	0	0	0	0%
Rear-to-Rear	0	0	0	0	0%
Pedestrian	0	0	0	0	0%
Other	0	0	0	0	0%
Unknown	0	0	0	0	0%
Accident Severity					
Property	12	11	10	33	89%
Injury	2	1	1	4	11%
Light Condition					
Daylight	12	9	6	27	73%
Dusk	0	0	0	0	0%
Dark - Lighted	1	3	5	9	24%
Dark - Unknown Lighting	0	0	0	0	0%
Other	1	0	0	1	3%
Road Condition					
Dry	12	10	9	31	84%
Wet	2	2	2	6	16%
Snow	0	0	0	0	0%
Slush	0	0	0	0	0%
Hour of Day					
6:00 AM - 9:00 AM	2	2	0	4	11%
9:00 AM - 3:00 PM	5	7	1	13	35%
3:00 PM - 6:00 PM	6	1	6	13	35%
6:00 PM - 6:00 AM	1	2	4	7	19%
Total Accidents:	0	3	4	37	

West Main Road at Access Road

	2017	2018	2019	Total	Percent
Collision Type					
Rear End	7	6	6	19	70%
Angle	1	0	1	2	7%
Head-On	1	0	0	1	4%
Sideswipe, Same Direction	1	1	1	3	11%
Sideswipe, Opposite Direction	0	0	0	0	0%
Rear-to-Side	0	0	0	0	0%
Rear-to-Rear	0	0	0	0	0%
Pedestrian	0	0	0	0	0%
Other	1	0	1	2	7%
Unknown	0	0	0	0	0%
Accident Severity					
Property	8	5	6	19	70%
Injury	3	2	3	8	30%
Light Condition					
Daylight	10	5	8	23	85%
Dusk	0	0	0	0	0%
Dark - Lighted	1	2	1	4	15%
Dark - Unknown Lighting	0	0	0	0	0%
Other	0	0	0	0	0%
Road Condition					
Dry	9	6	6	21	78%
Wet	1	1	3	5	19%
Snow	0	0	0	0	0%
Slush	1	0	0	1	4%
Hour of Day					
6:00 AM - 9:00 AM	3	0	1	4	15%
9:00 AM - 3:00 PM	4	3	6	13	48%
3:00 PM - 6:00 PM	3	3	1	7	26%
6:00 PM - 6:00 AM	1	1	1	3	11%
Total Accidents:	2	1	2	27	

West Main Road from Forest Avenue to Access Road

	2017	2018	2019	Total	Percent
Collision Type					
Rear End	4	1	2	7	64%
Angle	0	0	2	2	18%
Head-On	0	0	0	0	0%
Sideswipe, Same Direction	1	1	0	2	18%
Sideswipe, Opposite Direction	0	0	0	0	0%
Rear-to-Side	0	0	0	0	0%
Rear-to-Rear	0	0	0	0	0%
Pedestrian	0	0	0	0	0%
Other	0	0	0	0	0%
Unknown	0	0	0	0	0%
Accident Severity					
Property	5	2	4	11	100%
Injury	0	0	0	0	0%
Light Condition					
Daylight	5	2	4	11	100%
Dusk	0	0	0	0	0%
Dark - Lighted	0	0	0	0	0%
Dark - Unknown Lighting	0	0	0	0	0%
Other	0	0	0	0	0%
Road Condition					
Dry	3	1	3	7	64%
Wet	2	1	1	4	36%
Snow	0	0	0	0	0%
Slush	0	0	0	0	0%
Hour of Day					
6:00 AM - 9:00 AM	1	1	2	4	36%
9:00 AM - 3:00 PM	3	1	1	5	45%
3:00 PM - 6:00 PM	1	0	1	2	18%
6:00 PM - 6:00 AM	0	0	0	0	0%
Total Accidents:	1	1	0	11	

APPENDIX C – Trip Generation

ITE Trip Generation Summary

Site Trip Distribution

ITE Land Use Code

ITE Land Use Code 948 – Automated Car Wash

C

ITE Trip Generation Summary

Trip Generation Summary

Summary:

	<u>Description</u>	<u>Enter</u>	<u>Exit</u>	<u>Total</u>
<u>Weekday PM Peak Hour</u>				
ITE Land Use Code 948	Automated Car Wash	30	30	60
<u>Saturday MD Peak Hour</u>				
ITE Land Use Code 948	Automated Car Wash	64	64	128

Calculations;

ITE Land Use Code 948

Automated Car Wash

(4,200 SF)

Independent Variable (X) = 1000 Sq. Ft. GFA

X = 4.2

PM Peak

Directional Distribution:

50% Entering 50% Exiting

T = 14.20 (X)

Enter: 30

T = 14.20 4.2

Exit: 30

T = 60

Total: 60

Sat. MD Peak

Directional Distribution:

50% Entering 50% Exiting

T = 30.40 (X)

Enter: 64

T = 30.40 4.2

Exit: 64

T = 128

Total: 128

C

Site Trip Distribution

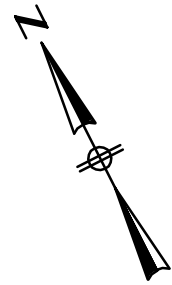

Route 114

15
15

Site Driveway
(Exit Only)

SITE

Site Trips:

Enter:	30
Exit:	<u>30</u>
Total:	60

15 15
↓ ↓

Site Driveway
(Enter Only)

15

5 10
↓ ↓

Access Road

East Bay Village

5 →

10
↑

West Main Road



www.BETA-Inc.com

**SITE TRIP DISTRIBUTION
WEEKDAY PM PEAK HOUR**

**Washville Car Wash
Middletown, Rhode Island**

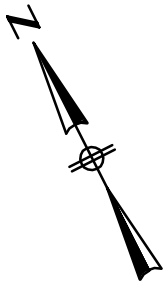

Route 114

32

32

Site Driveway
(Exit Only)

SITE

Site Trips:

Enter: 64

Exit: 64

Total: 128

32 32



Site Driveway
(Enter Only)

32



2 30



Access Road

East Bay Village

2

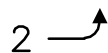

30



West Main Road



www.BETA-Inc.com

SITE TRIP DISTRIBUTION
SATURDAY MD PEAK HOUR

Washville Car Wash
Middletown, Rhode Island

C

ITE Land Use Code

ITE Land Use Code 948 – Automated Car Wash

ITE Land Use Code 948 – Automated Car Wash

Land Use: 948

Automated Car Wash

Description

An automated car wash is a facility that allows for the mechanical cleaning of the exterior of vehicles. Manual cleaning service may also be available at the facility. Self-service car wash (Land Use 947) and car wash and detail center (Land Use 949) are related uses.

Additional Data

The sites were surveyed in the 1990s and the 2000s in New Jersey, New York, and Washington.

Source Numbers

552, 555, 585, 599, 954

Automated Car Wash (948)

Vehicle Trip Ends vs: 1000 Sq. Ft. GFA

On a: **Weekday,**

Peak Hour of Adjacent Street Traffic,

One Hour Between 4 and 6 p.m.

Setting/Location: General Urban/Suburban

Number of Studies: 1

Avg. 1000 Sq. Ft. GFA: 2

Directional Distribution: 50% entering, 50% exiting

Vehicle Trip Generation per 1000 Sq. Ft. GFA

Average Rate	Range of Rates	Standard Deviation
14.20	14.20 - 14.20	***

Data Plot and Equation

Caution – Small Sample Size

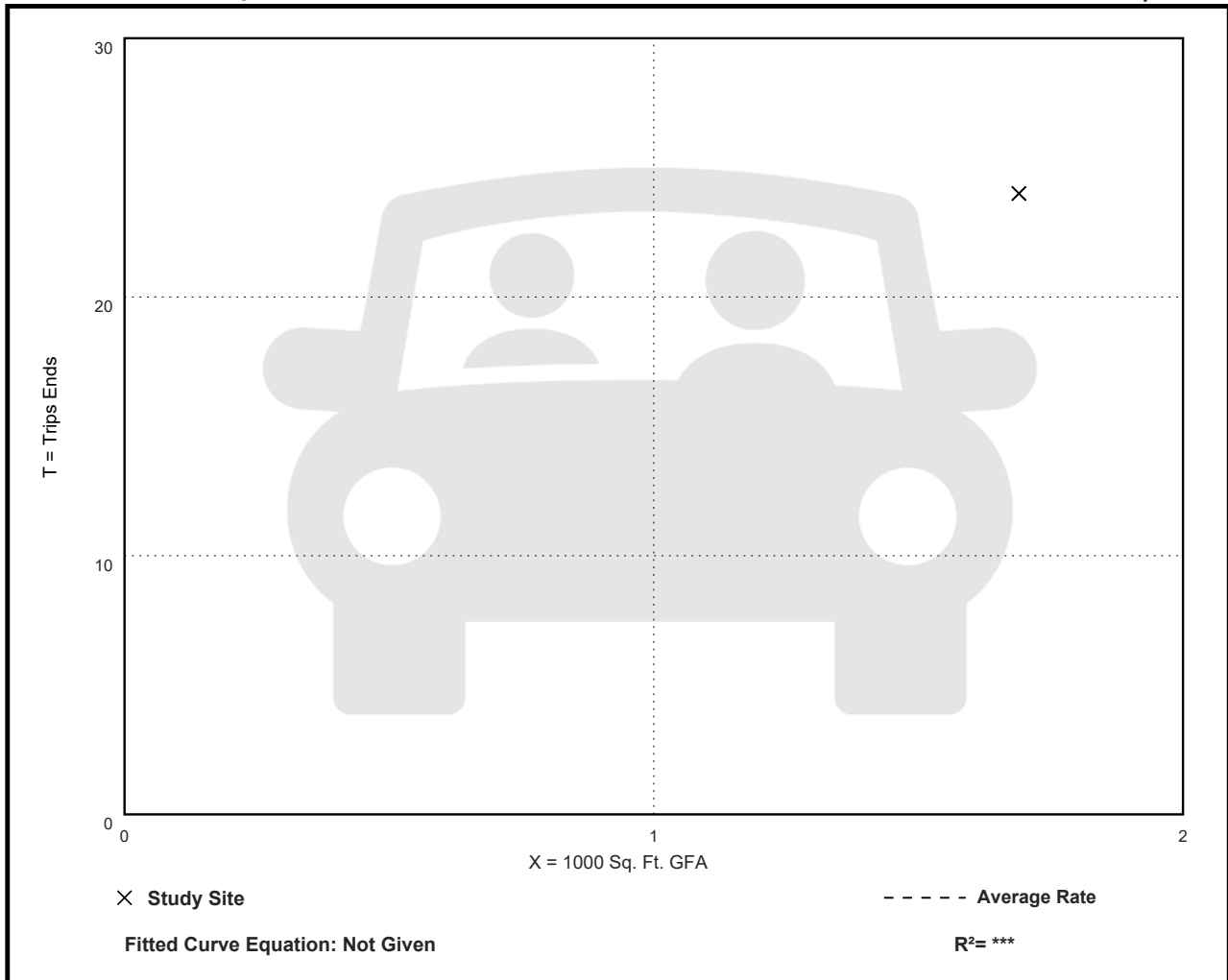

Automated Car Wash (948)

Vehicle Trip Ends vs: 1000 Sq. Ft. GFA

On a: Saturday, Peak Hour of Generator

Setting/Location: General Urban/Suburban

Number of Studies: 3

Avg. 1000 Sq. Ft. GFA: 4

Directional Distribution: 50% entering, 50% exiting

Vehicle Trip Generation per 1000 Sq. Ft. GFA

Average Rate	Range of Rates	Standard Deviation
30.40	14.20 - 37.75	9.63

Data Plot and Equation

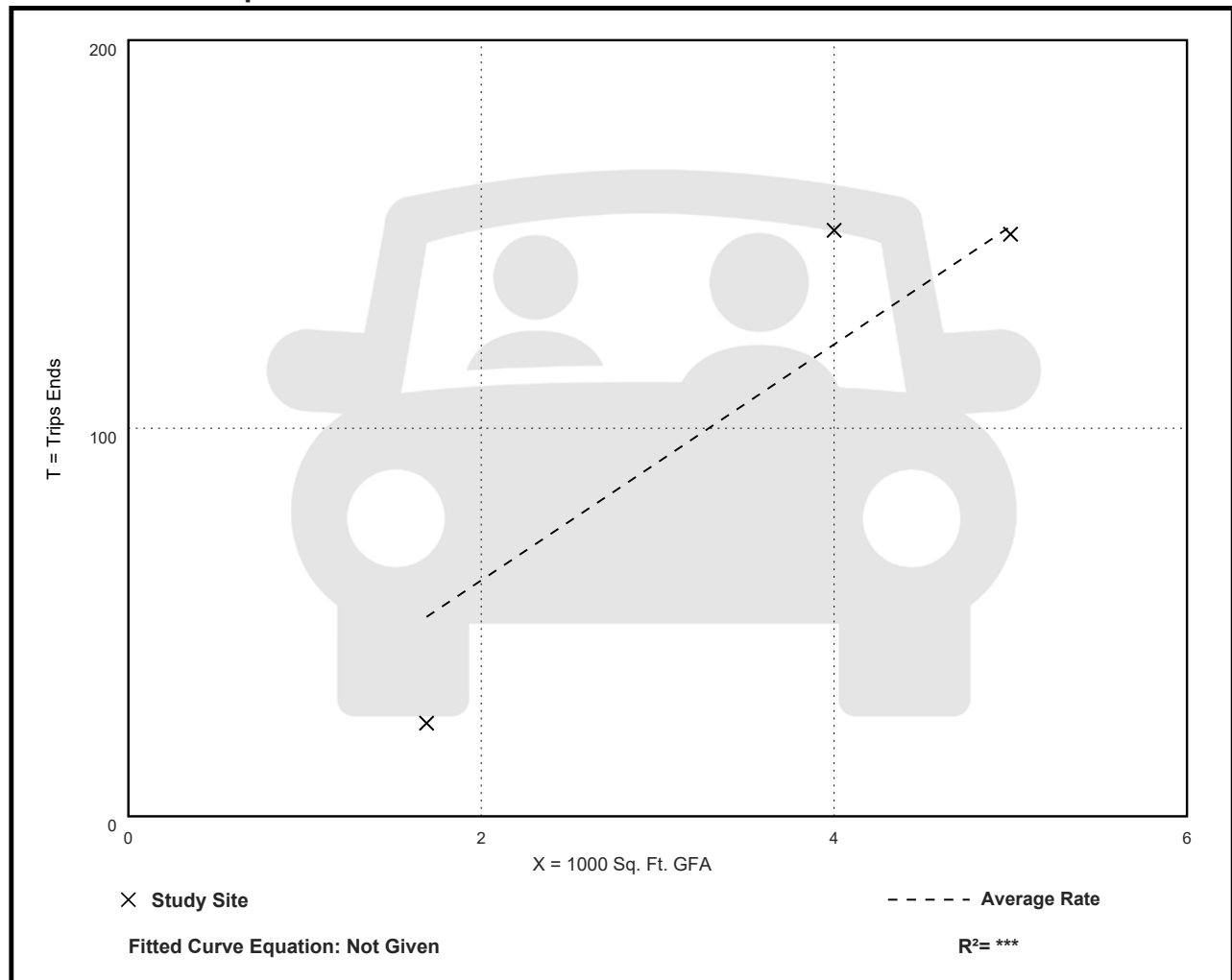

APPENDIX D – Operational Analysis

Existing Conditions

West Main Road (Route 114) at Access Road/East Bay Village

Future Build Conditions

West Main Road (Route 114) at Access Road/East Bay Village

West Main Road (Route 114) at South Site Driveway

West Main Road (Route 114) at North Site Driveway

D

Existing Weekday PM / Saturday MD Peak Hour

West Main Road (Route 114) at Access Road/East Bay Village

West Main Road (Route 114) at Access Road/East Bay Village



www.BETA-Inc.com

Turning Movement Diagram

Major Street:	West Main Rd. (Rte. 114)	Minor Street:	Access Rd./East Bay Village
City/Town:	Middletown, RI	Day of Week:	Weekday
Reference No.:	10432	Peak Period:	4:00 PM - 5:00 PM
Existing:	PM Peak Hour	Future:	n/a

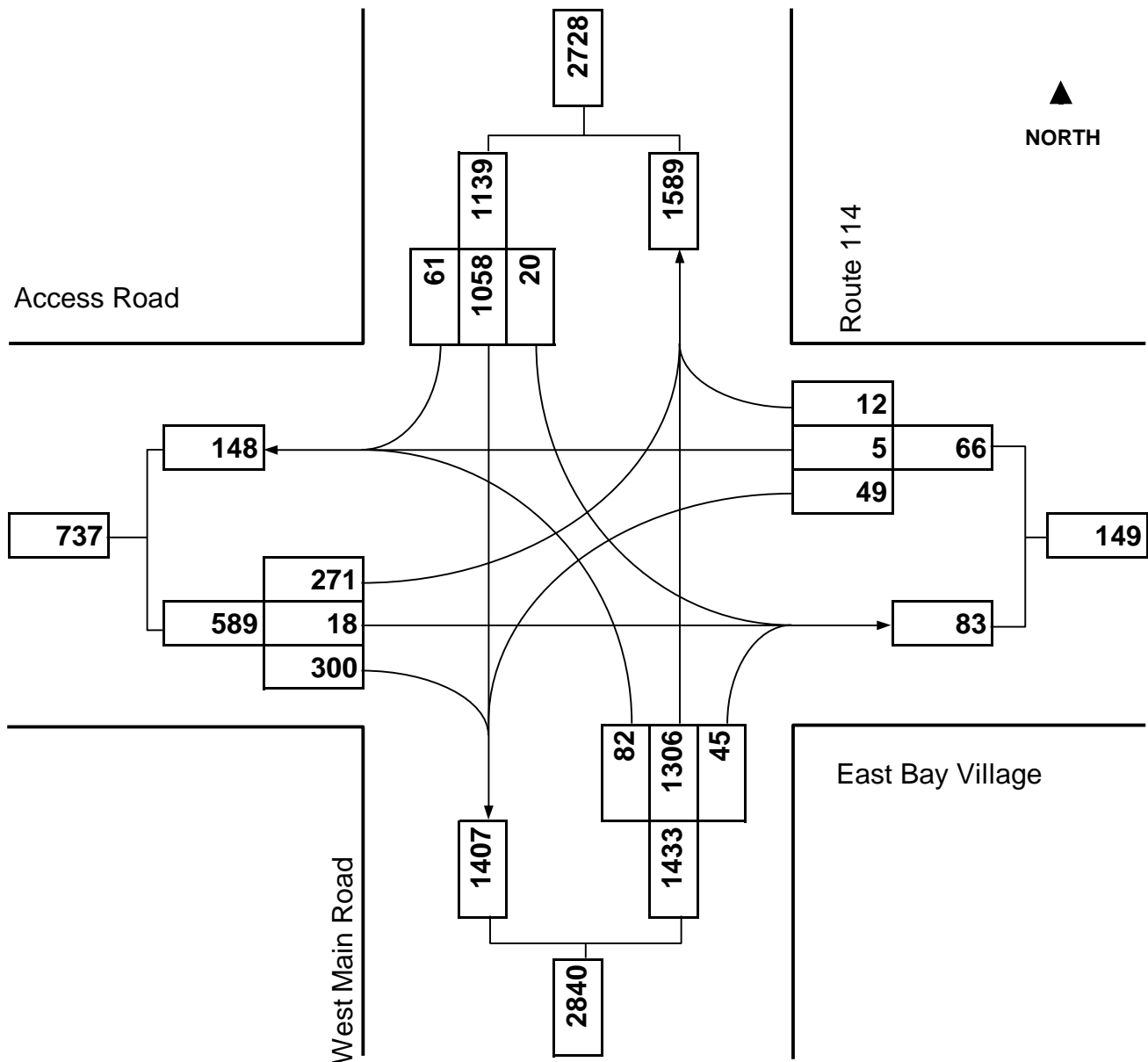

Washville Car Wash
West Main Road (Rte. 114) at Access Road/East Bay Village

04/27/2022
Middletown, RI



Lane Group	EBL	EBT	EBR	WBL	WBT	WBR	NBL	NBT	NBR	SBL	SBT	SBR
Lane Configurations	↖	↗			↔		↖	↗		↖	↗	
Traffic Volume (vph)	271	18	300	49	5	12	82	1306	45	20	1058	61
Future Volume (vph)	271	18	300	49	5	12	82	1306	45	20	1058	61
Satd. Flow (prot)	1805	1632	0	0	1786	0	1745	3406	0	1745	3397	0
Flt Permitted	0.744				0.557		0.950			0.950		
Satd. Flow (perm)	1414	1632	0	0	1032	0	1745	3406	0	1745	3397	0
Satd. Flow (RTOR)		258			13			5			8	
Lane Group Flow (vph)	285	335	0	0	70	0	86	1422	0	21	1178	0
Turn Type	Perm	NA		Perm	NA		Prot	NA		Prot	NA	
Protected Phases		4			8		1	6		5	2	
Permitted Phases	4			8								
Total Split (s)	31.0	31.0		31.0	31.0		15.0	44.0		15.0	44.0	
Total Lost Time (s)	4.5	4.5			4.5		4.5	5.0		4.5	5.0	
Act Effct Green (s)	26.5	26.5			26.5		8.8	49.2		6.6	40.7	
Actuated g/C Ratio	0.29	0.29			0.29		0.10	0.55		0.07	0.45	
v/c Ratio	0.69	0.51			0.22		0.50	0.76		0.16	0.77	
Control Delay	37.9	9.7			22.5		48.4	20.9		41.8	25.0	
Queue Delay	0.0	0.0			0.0		0.0	0.0		0.0	0.0	
Total Delay	37.9	9.7			22.5		48.4	20.9		41.8	25.0	
LOS	D	A			C		D	C		D	C	
Approach Delay		22.7			22.5			22.4			25.3	
Approach LOS		C			C			C			C	
Queue Length 50th (ft)	143	32			24		47	267		12	287	
Queue Length 95th (ft)	234	106			59		92	#532		34	380	
Internal Link Dist (ft)		420			180			893			885	
Turn Bay Length (ft)	100						110			110		
Base Capacity (vph)	416	662			313		203	1864		203	1539	
Starvation Cap Reductn	0	0			0		0	0		0	0	
Spillback Cap Reductn	0	0			0		0	0		0	0	
Storage Cap Reductn	0	0			0		0	0		0	0	
Reduced v/c Ratio	0.69	0.51			0.22		0.42	0.76		0.10	0.77	

Intersection Summary

Cycle Length: 90
 Actuated Cycle Length: 90
 Offset: 31 (34%), Referenced to phase 2:SBT and 6:NBT, Start of Green
 Control Type: Actuated-Coordinated
 Maximum v/c Ratio: 0.77
 Intersection Signal Delay: 23.5
 Intersection LOS: C
 Intersection Capacity Utilization 82.4%
 ICU Level of Service E
 Analysis Period (min) 15
 # 95th percentile volume exceeds capacity, queue may be longer.
 Queue shown is maximum after two cycles.

Splits and Phases: 4: West Main Road (Rte. 114) & Access Road/East Bay Village

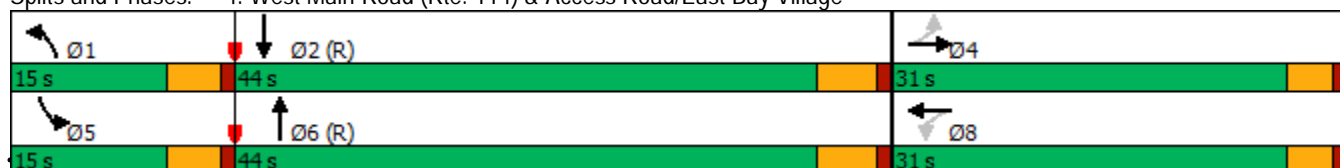

Existing Conditions
Timing Plan: Weekday PM Peak Hour



www.BETA-Inc.com

Turning Movement Diagram

Major Street:	West Main Rd. (Rte. 114)	Minor Street:	Access Rd./East Bay Village
City/Town:	Middletown, RI	Day of Week:	Saturday
Reference No.:	10432	Peak Period:	12:00 PM - 1:00 PM
Existing:	MD Peak Hour	Future:	n/a

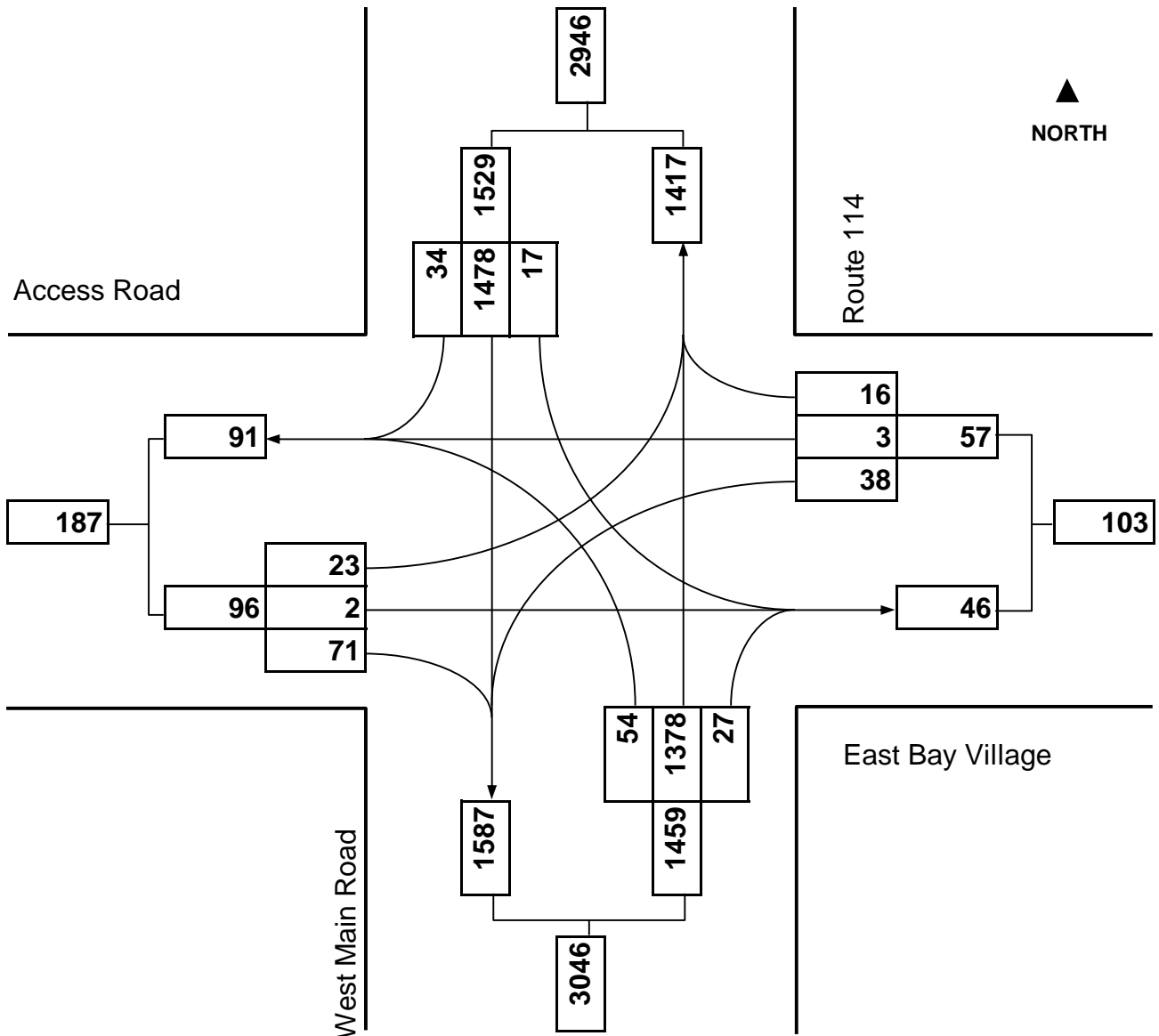

Washville Car Wash
 West Main Road (Rte. 114) at Access Road/East Bay Village

04/30/2022
 Middletown, RI

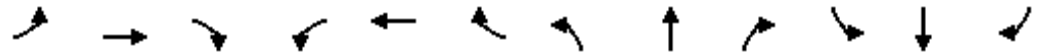

Lane Group	EBL	EBT	EBR	WBL	WBT	WBR	NBL	NBT	NBR	SBL	SBT	SBR
Lane Configurations	↖	↗			↔		↖	↗		↖	↗	
Traffic Volume (vph)	23	2	71	38	3	16	54	1378	27	17	1478	34
Future Volume (vph)	23	2	71	38	3	16	54	1378	27	17	1478	34
Satd. Flow (prot)	1805	1623	0	0	1769	0	1745	3412	0	1745	3412	0
Flt Permitted	0.764				0.817		0.950			0.950		
Satd. Flow (perm)	1452	1623	0	0	1495	0	1745	3412	0	1745	3412	0
Satd. Flow (RTOR)		72			16			3			3	
Lane Group Flow (vph)	23	74	0	0	58	0	55	1434	0	17	1543	0
Turn Type	Perm	NA		Perm	NA		Prot	NA		Prot	NA	
Protected Phases		4			8		1	6		5	2	
Permitted Phases	4			8								
Total Split (s)	31.0	31.0		31.0	31.0		15.0	44.0		15.0	44.0	
Total Lost Time (s)	4.5	4.5			4.5		4.5	5.0		4.5	5.0	
Act Effct Green (s)	26.5	26.5			26.5		8.0	49.4		6.4	41.5	
Actuated g/C Ratio	0.29	0.29			0.29		0.09	0.55		0.07	0.46	
v/c Ratio	0.05	0.14			0.13		0.35	0.77		0.14	0.98	
Control Delay	23.3	7.2			19.1		44.4	20.8		41.4	43.8	
Queue Delay	0.0	0.0			0.0		0.0	0.0		0.0	0.0	
Total Delay	23.3	7.2			19.1		44.4	20.8		41.4	43.8	
LOS	C	A			B		D	C		D	D	
Approach Delay		11.0			19.1			21.7			43.7	
Approach LOS		B			B			C			D	
Queue Length 50th (ft)	9	1			17		30	271		9	434	
Queue Length 95th (ft)	28	31			46		65	#534		30	#643	
Internal Link Dist (ft)		420			180			893			885	
Turn Bay Length (ft)	100						110			110		
Base Capacity (vph)	427	528			451		203	1872		203	1574	
Starvation Cap Reductn	0	0			0		0	0		0	0	
Spillback Cap Reductn	0	0			0		0	0		0	0	
Storage Cap Reductn	0	0			0		0	0		0	0	
Reduced v/c Ratio	0.05	0.14			0.13		0.27	0.77		0.08	0.98	

Intersection Summary

Cycle Length: 90
 Actuated Cycle Length: 90
 Offset: 31 (34%), Referenced to phase 2:SBT and 6:NBT, Start of Green
 Control Type: Actuated-Coordinated
 Maximum v/c Ratio: 0.98
 Intersection Signal Delay: 32.1
 Intersection LOS: C
 Intersection Capacity Utilization 62.7%
 ICU Level of Service B
 Analysis Period (min) 15
 # 95th percentile volume exceeds capacity, queue may be longer.
 Queue shown is maximum after two cycles.

Splits and Phases: 4: West Main Road (Rte. 114) & Access Road/East Bay Village

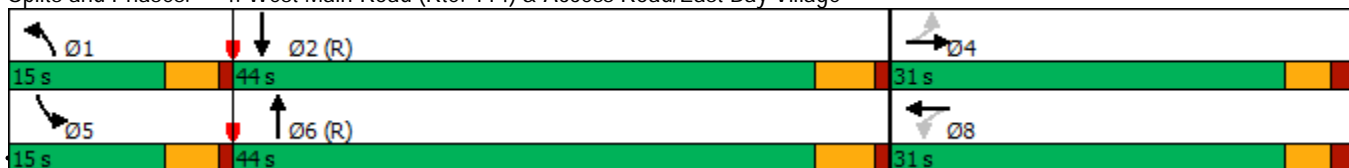

Existing Conditions
 Timing Plan: Saturday MD Peak Hour

D

Future Build Weekday PM / Saturday MD Peak Hour

West Main Road (Route 114) at Access Road/East Bay Village

West Main Road (Route 114) at South Site Driveway

West Main Road (Route 114) at North Site Driveway

West Main Road (Route 114) at Access Road/East Bay Village



www.BETA-Inc.com

Turning Movement Diagram

Major Street:	West Main Rd. (Rte. 114)	Minor Street:	Access Rd./East Bay Village
City/Town:	Middletown, RI	Day of Week:	Weekday
Reference No.:	10432	Peak Period:	PM Peak Hour
Existing:	n/a	Future:	2025 Build

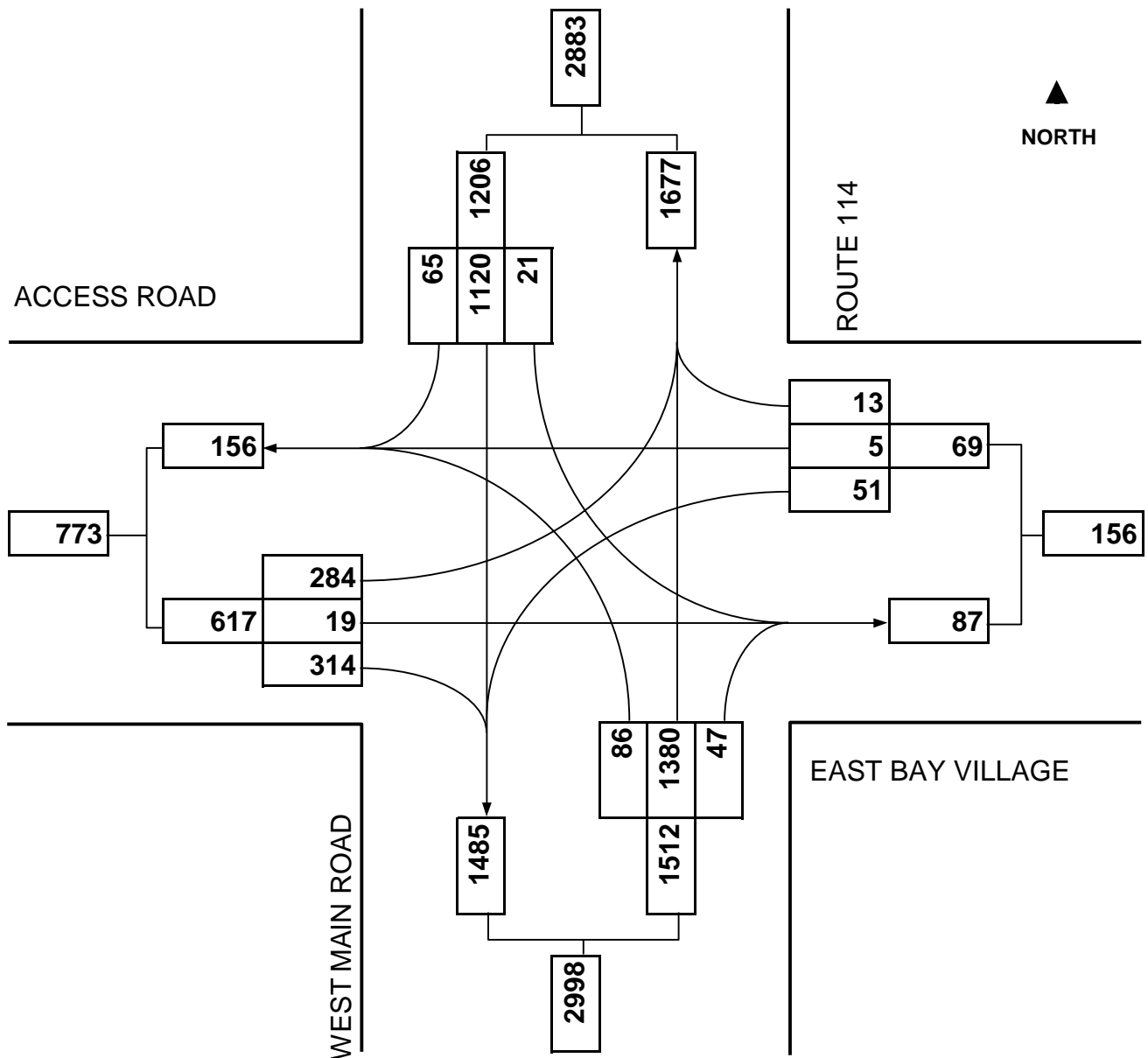

Washville Car Wash
 West Main Road (Rte. 114) at Access Road/East Bay Village

04/27/2022
 Middletown, RI

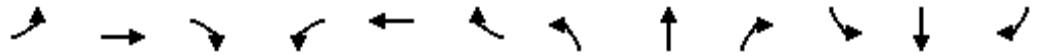

Lane Group	EBL	EBT	EBR	WBL	WBT	WBR	NBL	NBT	NBR	SBL	SBT	SBR
Lane Configurations	↖	↗			↔		↖	↕		↖	↕	
Traffic Volume (vph)	284	19	314	51	5	13	86	1380	47	21	1120	65
Future Volume (vph)	284	19	314	51	5	13	86	1380	47	21	1120	65
Satd. Flow (prot)	1805	1632	0	0	1784	0	1745	3406	0	1745	3398	0
Flt Permitted	0.741				0.526		0.950			0.950		
Satd. Flow (perm)	1408	1632	0	0	973	0	1745	3406	0	1745	3398	0
Satd. Flow (RTOR)		253			13			5			8	
Lane Group Flow (vph)	299	351	0	0	73	0	91	1502	0	22	1247	0
Turn Type	Perm	NA		Perm	NA		Prot	NA		Prot	NA	
Protected Phases		4			8		1	6		5	2	
Permitted Phases	4			8								
Total Split (s)	31.0	31.0		31.0	31.0		15.0	44.0		15.0	44.0	
Total Lost Time (s)	4.5	4.5			4.5		4.5	5.0		4.5	5.0	
Act Effct Green (s)	26.5	26.5			26.5		8.9	49.2		6.7	40.6	
Actuated g/C Ratio	0.29	0.29			0.29		0.10	0.55		0.07	0.45	
v/c Ratio	0.72	0.53			0.25		0.53	0.81		0.17	0.81	
Control Delay	40.1	11.1			23.0		49.4	22.6		41.8	27.0	
Queue Delay	0.0	0.0			0.0		0.0	0.0		0.0	0.0	
Total Delay	40.1	11.1			23.0		49.4	22.6		41.8	27.0	
LOS	D	B			C		D	C		D	C	
Approach Delay		24.4			23.0			24.1			27.2	
Approach LOS		C			C			C			C	
Queue Length 50th (ft)	152	42			26		50	293		12	315	
Queue Length 95th (ft)	#267	121			62		97	#586		35	415	
Internal Link Dist (ft)		420			180			893			160	
Turn Bay Length (ft)	100						110			110		
Base Capacity (vph)	414	659			295		203	1863		203	1536	
Starvation Cap Reductn	0	0			0		0	0		0	0	
Spillback Cap Reductn	0	0			0		0	0		0	0	
Storage Cap Reductn	0	0			0		0	0		0	0	
Reduced v/c Ratio	0.72	0.53			0.25		0.45	0.81		0.11	0.81	

Intersection Summary

Cycle Length: 90
 Actuated Cycle Length: 90
 Offset: 31 (34%), Referenced to phase 2:SBT and 6:NBT, Start of Green
 Control Type: Actuated-Coordinated
 Maximum v/c Ratio: 0.81
 Intersection Signal Delay: 25.3
 Intersection LOS: C
 Intersection Capacity Utilization 85.5%
 ICU Level of Service E
 Analysis Period (min) 15
 # 95th percentile volume exceeds capacity, queue may be longer.
 Queue shown is maximum after two cycles.

Splits and Phases: 4: West Main Road (Rte. 114) & Access Road/East Bay Village

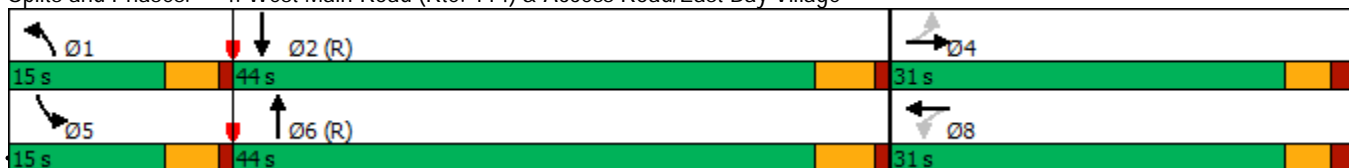

Future 2025 Build Conditions
 Timing Plan: Weekday PM Peak Hour



www.BETA-Inc.com

Turning Movement Diagram

Major Street:	West Main Rd. (Rte. 114)	Minor Street:	Access Rd./East Bay Village
City/Town:	Middletown, RI	Day of Week:	Saturday
Reference No.:	10432	Peak Period:	MD Peak Hour
Existing:	n/a	Future:	2025 Build

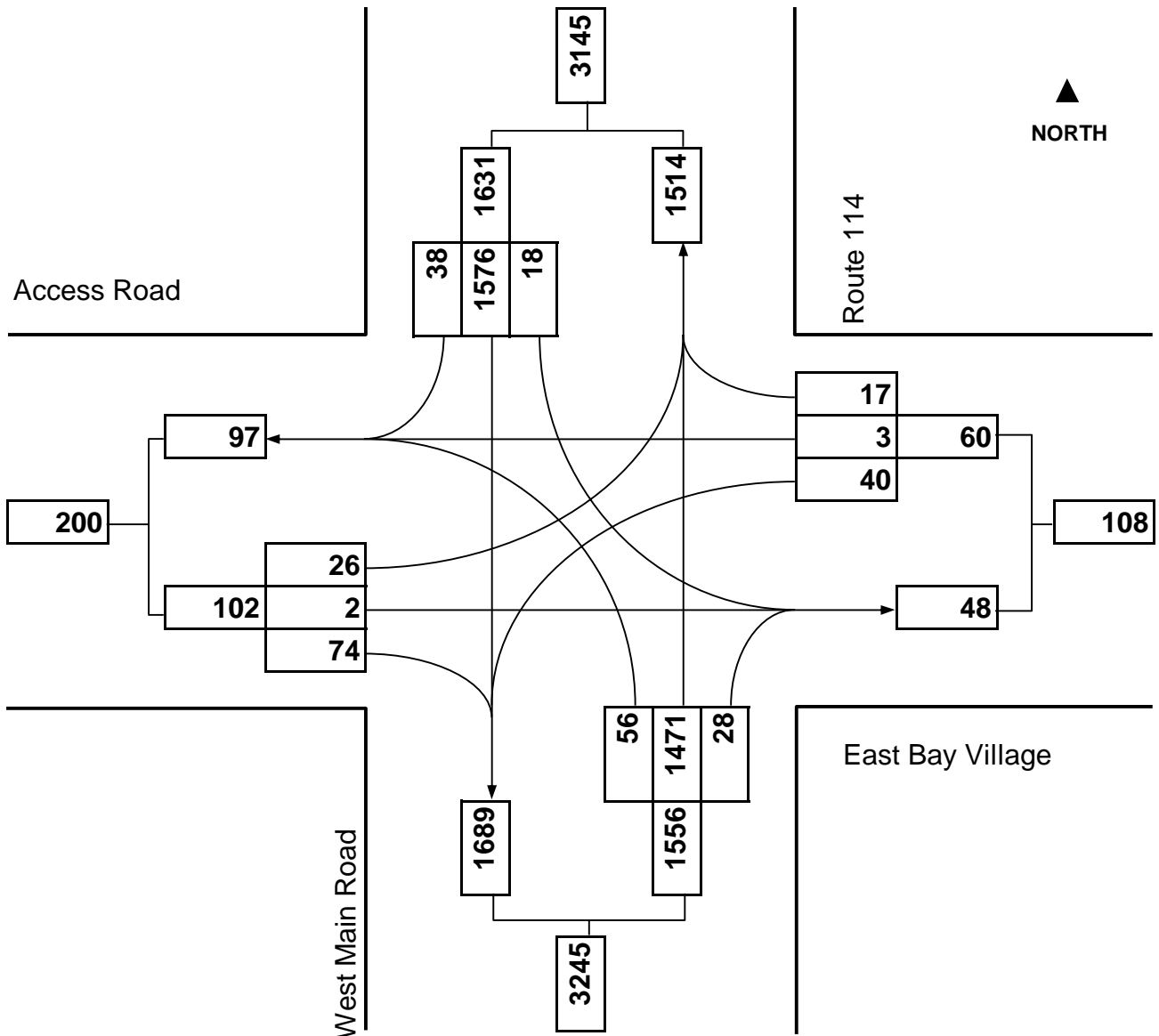

Washville Car Wash
 West Main Road (Rte. 114) at Access Road/East Bay Village

04/30/2022
 Middletown, RI

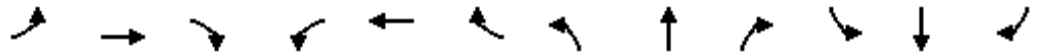

Lane Group	EBL	EBT	EBR	WBL	WBT	WBR	NBL	NBT	NBR	SBL	SBT	SBR
Lane Configurations	↖	↗			↔		↖	↕		↖	↕	
Traffic Volume (vph)	26	2	74	40	3	17	56	1471	28	18	1576	38
Future Volume (vph)	26	2	74	40	3	17	56	1471	28	18	1576	38
Satd. Flow (prot)	1805	1623	0	0	1767	0	1745	3412	0	1745	3409	0
Flt Permitted	0.775				0.771		0.950			0.950		
Satd. Flow (perm)	1472	1623	0	0	1409	0	1745	3412	0	1745	3409	0
Satd. Flow (RTOR)		76			17			4			5	
Lane Group Flow (vph)	27	78	0	0	61	0	57	1530	0	18	1647	0
Turn Type	Perm	NA		Perm	NA		Prot	NA		Prot	NA	
Protected Phases		4			8		1	6		5	2	
Permitted Phases	4			8								
Total Split (s)	18.0	18.0		18.0	18.0		13.0	59.0		13.0	59.0	
Total Lost Time (s)	4.5	4.5			4.5		4.5	5.0		4.5	5.0	
Act Effct Green (s)	13.5	13.5			13.5		7.5	62.3		6.5	55.0	
Actuated g/C Ratio	0.15	0.15			0.15		0.08	0.69		0.07	0.61	
v/c Ratio	0.12	0.25			0.27		0.39	0.65		0.14	0.79	
Control Delay	34.8	11.2			29.8		46.9	10.4		41.4	16.9	
Queue Delay	0.0	0.0			0.0		0.0	0.0		0.0	0.0	
Total Delay	34.8	11.2			29.8		46.9	10.4		41.4	16.9	
LOS	C	B			C		D	B		D	B	
Approach Delay		17.3			29.8			11.7			17.2	
Approach LOS		B			C			B			B	
Queue Length 50th (ft)	13	1			22		31	171		10	341	
Queue Length 95th (ft)	38	40			59		69	379		31	448	
Internal Link Dist (ft)		420			180			893			160	
Turn Bay Length (ft)	100						110			110		
Base Capacity (vph)	220	308			225		164	2364		164	2084	
Starvation Cap Reductn	0	0			0		0	0		0	0	
Spillback Cap Reductn	0	0			0		0	0		0	0	
Storage Cap Reductn	0	0			0		0	0		0	0	
Reduced v/c Ratio	0.12	0.25			0.27		0.35	0.65		0.11	0.79	

Intersection Summary

Cycle Length: 90
 Actuated Cycle Length: 90
 Offset: 31 (34%), Referenced to phase 2:SBT and 6:NBT, Start of Green
 Control Type: Actuated-Coordinated
 Maximum v/c Ratio: 0.79
 Intersection Signal Delay: 14.9
 Intersection LOS: B
 Intersection Capacity Utilization 64.5%
 ICU Level of Service C
 Analysis Period (min) 15

Splits and Phases: 4: West Main Road (Rte. 114) & Access Road/East Bay Village

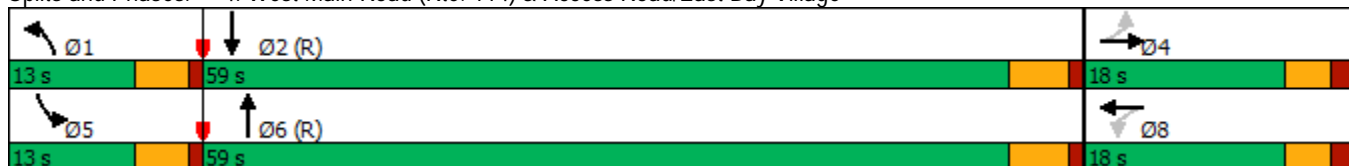

West Main Road (Route 114) at South Site Driveway



www.BETA-Inc.com

Turning Movement Diagram

Major Street: West Main Rd. (Rte. 114)

Minor Street: South Site Driveway

City/Town: Middletown, RI

Day of Week: Weekday

Reference No.: 10432

Peak Period: PM Peak Hour

Existing: n/a

Future: 2025 Build

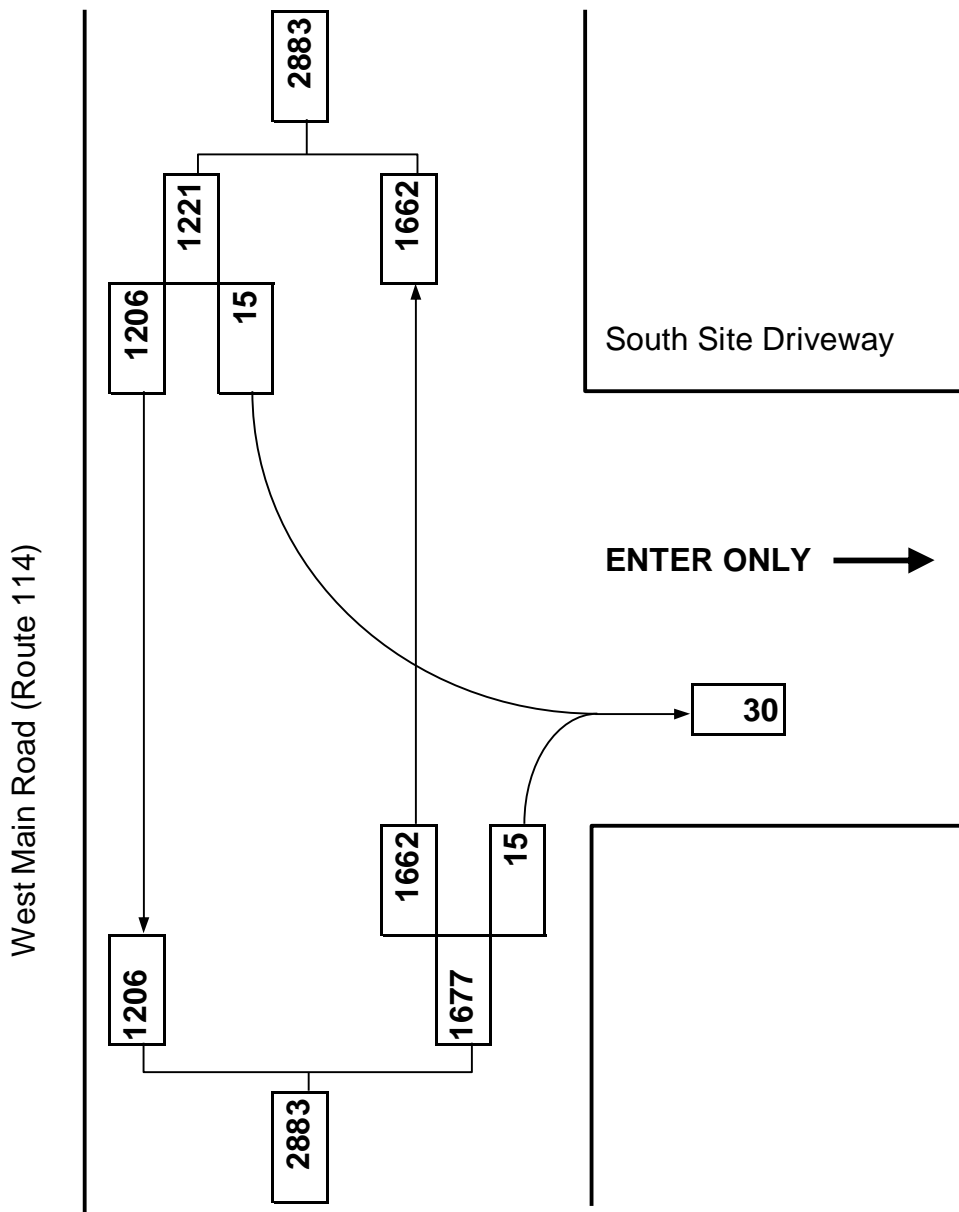

Washville Car Wash
West Main Road (Rte. 114) at South Site Driveway

04/27/2022
Middletown, RI



Movement	WBL	WBR	NBT	NBR	SBL	SBT
Lane Configurations			↑↑			↑↑
Traffic Volume (veh/h)	0	0	1662	15	15	1206
Future Volume (Veh/h)	0	0	1662	15	15	1206
Sign Control	Stop		Free			Free
Grade	0%		0%			0%
Peak Hour Factor	0.92	0.92	0.92	0.92	0.92	0.92
Hourly flow rate (vph)	0	0	1807	16	16	1311
Pedestrians						
Lane Width (ft)						
Walking Speed (ft/s)						
Percent Blockage						
Right turn flare (veh)						
Median type			None			None
Median storage veh						
Upstream signal (ft)			240			
pX, platoon unblocked	0.61	0.61			0.61	
vC, conflicting volume	2502	912			1823	
vC1, stage 1 conf vol						
vC2, stage 2 conf vol						
vCu, unblocked vol	2188	0			1080	
tC, single (s)	6.8	6.9			4.1	
tC, 2 stage (s)						
tF (s)	3.5	3.3			2.2	
p0 queue free %	100	100			96	
cM capacity (veh/h)	23	669			401	

Direction, Lane #	NB 1	NB 2	SB 1	SB 2
Volume Total	1205	618	453	874
Volume Left	0	0	16	0
Volume Right	0	16	0	0
cSH	1700	1700	401	1700
Volume to Capacity	0.71	0.36	0.04	0.51
Queue Length 95th (ft)	0	0	3	0
Control Delay (s)	0.0	0.0	1.3	0.0
Lane LOS			A	
Approach Delay (s)	0.0		0.4	
Approach LOS				

Intersection Summary			
Average Delay		0.2	
Intersection Capacity Utilization		49.8%	ICU Level of Service A
Analysis Period (min)		15	

Turning Movement Diagram

Major Street:	West Main Rd. (Rte. 114)	Minor Street:	South Site Driveway
City/Town:	Middletown, RI	Day of Week:	Saturday
Reference No.:	10432	Peak Period:	MD Peak Hour
Existing:	n/a	Future:	2025 Build

▲
NORTH

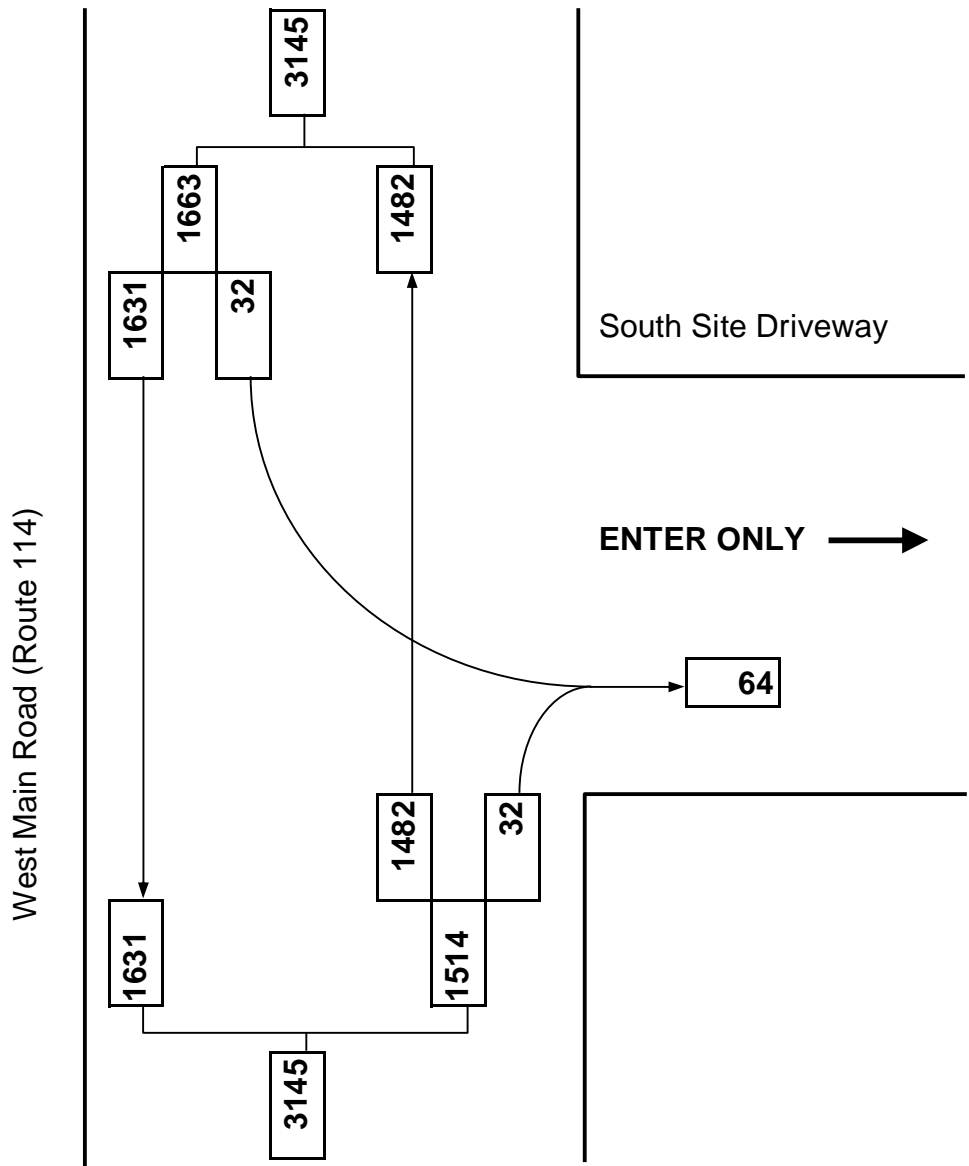

Washville Car Wash
West Main Road (Rte. 114) at South Site Driveway

04/30/2022
Middletown, RI



Movement	WBL	WBR	NBT	NBR	SBL	SBT
Lane Configurations			↑↑			↑↑
Traffic Volume (veh/h)	0	0	1482	32	32	1631
Future Volume (Veh/h)	0	0	1482	32	32	1631
Sign Control	Stop		Free			Free
Grade	0%		0%			0%
Peak Hour Factor	0.92	0.92	0.92	0.92	0.92	0.92
Hourly flow rate (vph)	0	0	1611	35	35	1773
Pedestrians						
Lane Width (ft)						
Walking Speed (ft/s)						
Percent Blockage						
Right turn flare (veh)						
Median type			None			None
Median storage veh						
Upstream signal (ft)			240			
pX, platoon unblocked	0.60	0.60			0.60	
vC, conflicting volume	2585	823			1646	
vC1, stage 1 conf vol						
vC2, stage 2 conf vol						
vCu, unblocked vol	2308	0			742	
tC, single (s)	6.8	6.9			4.1	
tC, 2 stage (s)						
tF (s)	3.5	3.3			2.2	
p0 queue free %	100	100			93	
cM capacity (veh/h)	18	654			524	

Direction, Lane #	NB 1	NB 2	SB 1	SB 2
Volume Total	1074	572	626	1182
Volume Left	0	0	35	0
Volume Right	0	35	0	0
cSH	1700	1700	524	1700
Volume to Capacity	0.63	0.34	0.07	0.70
Queue Length 95th (ft)	0	0	5	0
Control Delay (s)	0.0	0.0	1.9	0.0
Lane LOS			A	
Approach Delay (s)	0.0		0.7	
Approach LOS				

Intersection Summary			
Average Delay		0.3	
Intersection Capacity Utilization		71.2%	ICU Level of Service C
Analysis Period (min)		15	

West Main Road (Route 114) at North Site Driveway



www.BETA-Inc.com

Turning Movement Diagram

Major Street: West Main Rd. (Rte. 114)

Minor Street: North Site Driveway

City/Town: Middletown, RI

Day of Week: Weekday

Reference No.: 10432

Peak Period: PM Peak Hour

Existing: n/a

Future: 2025 Build

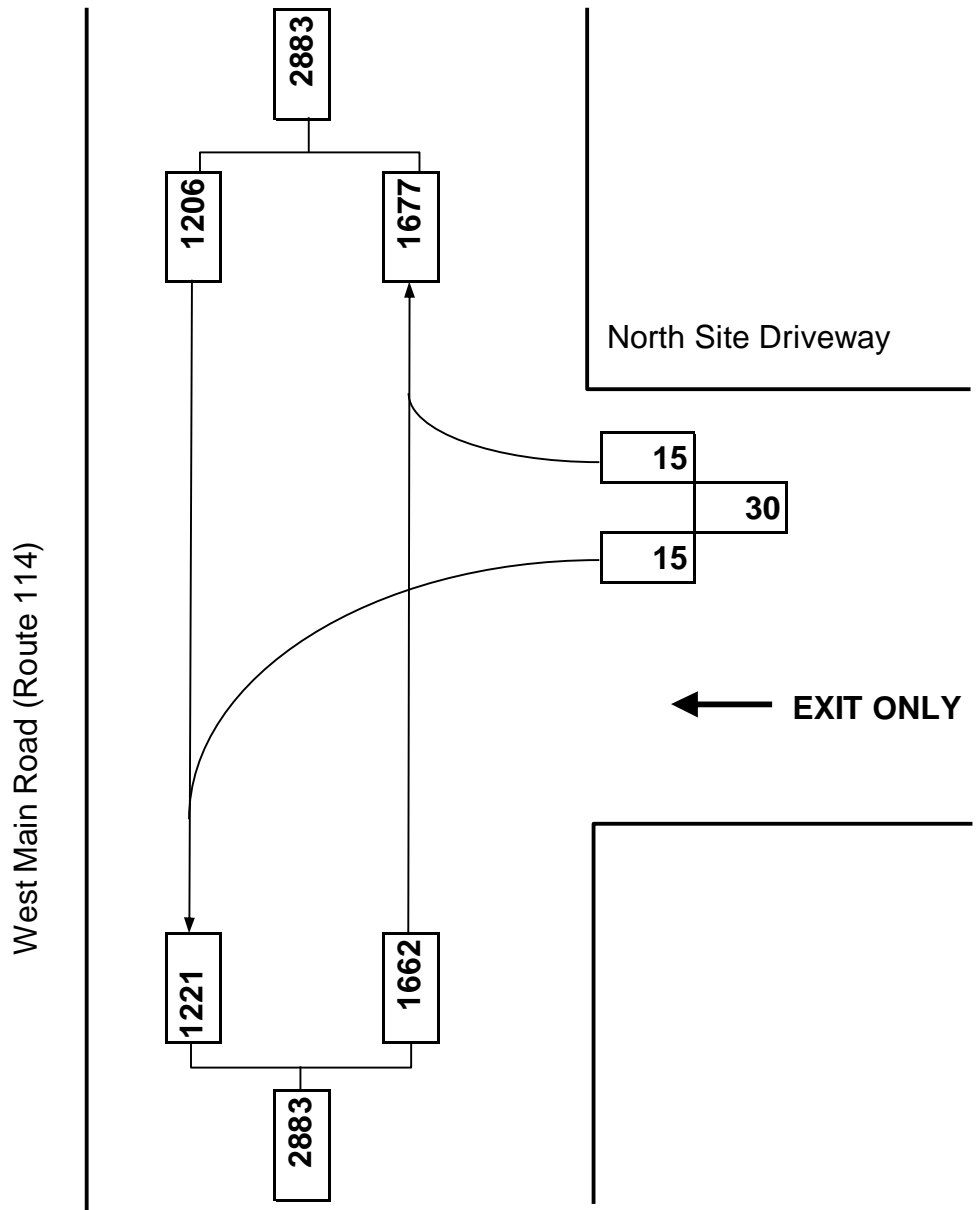

Intersection

Int Delay, s/veh 1.5

Movement	WBL	WBR	NBT	NBR	SBL	SBT
Lane Configurations	↘	↗	↕↕			↕↕
Traffic Vol, veh/h	15	15	1662	0	0	1206
Future Vol, veh/h	15	15	1662	0	0	1206
Conflicting Peds, #/hr	0	0	0	0	0	0
Sign Control	Stop	Stop	Free	Free	Free	Free
RT Channelized	-	None	-	None	-	None
Storage Length	0	0	-	-	-	-
Veh in Median Storage, #	0	-	0	-	-	0
Grade, %	0	-	0	-	-	0
Peak Hour Factor	92	92	92	92	92	92
Heavy Vehicles, %	0	0	2	0	0	2
Mvmt Flow	16	16	1807	0	0	1311

Major/Minor	Minor1	Major1	Major2
Conflicting Flow All	2463	904	0
Stage 1	1807	-	-
Stage 2	656	-	-
Critical Hdwy	6.8	6.9	-
Critical Hdwy Stg 1	5.8	-	-
Critical Hdwy Stg 2	5.8	-	-
Follow-up Hdwy	3.5	3.3	-
Pot Cap-1 Maneuver	26	284	-
Stage 1	119	-	0
Stage 2	483	-	0
Platoon blocked, %			-
Mov Cap-1 Maneuver	26	284	-
Mov Cap-2 Maneuver	26	-	-
Stage 1	119	-	-
Stage 2	483	-	-

Approach	WB	NB	SB
HCM Control Delay, s	146.4	0	0
HCM LOS	F		

Minor Lane/Major Mvmt	NBTWBLn1	WBLn2	SBT
Capacity (veh/h)	-	26	284
HCM Lane V/C Ratio	-	0.627	0.057
HCM Control Delay (s)	-	274.3	18.4
HCM Lane LOS	-	F	C
HCM 95th %tile Q(veh)	-	1.9	0.2



www.BETA-Inc.com

Turning Movement Diagram

Major Street:	West Main Rd. (Rte. 114)	Minor Street:	North Site Driveway
City/Town:	Middletown, RI	Day of Week:	Saturday
Reference No.:	10432	Peak Period:	MD Peak Hour
Existing:	n/a	Future:	2025 Build

▲
NORTH

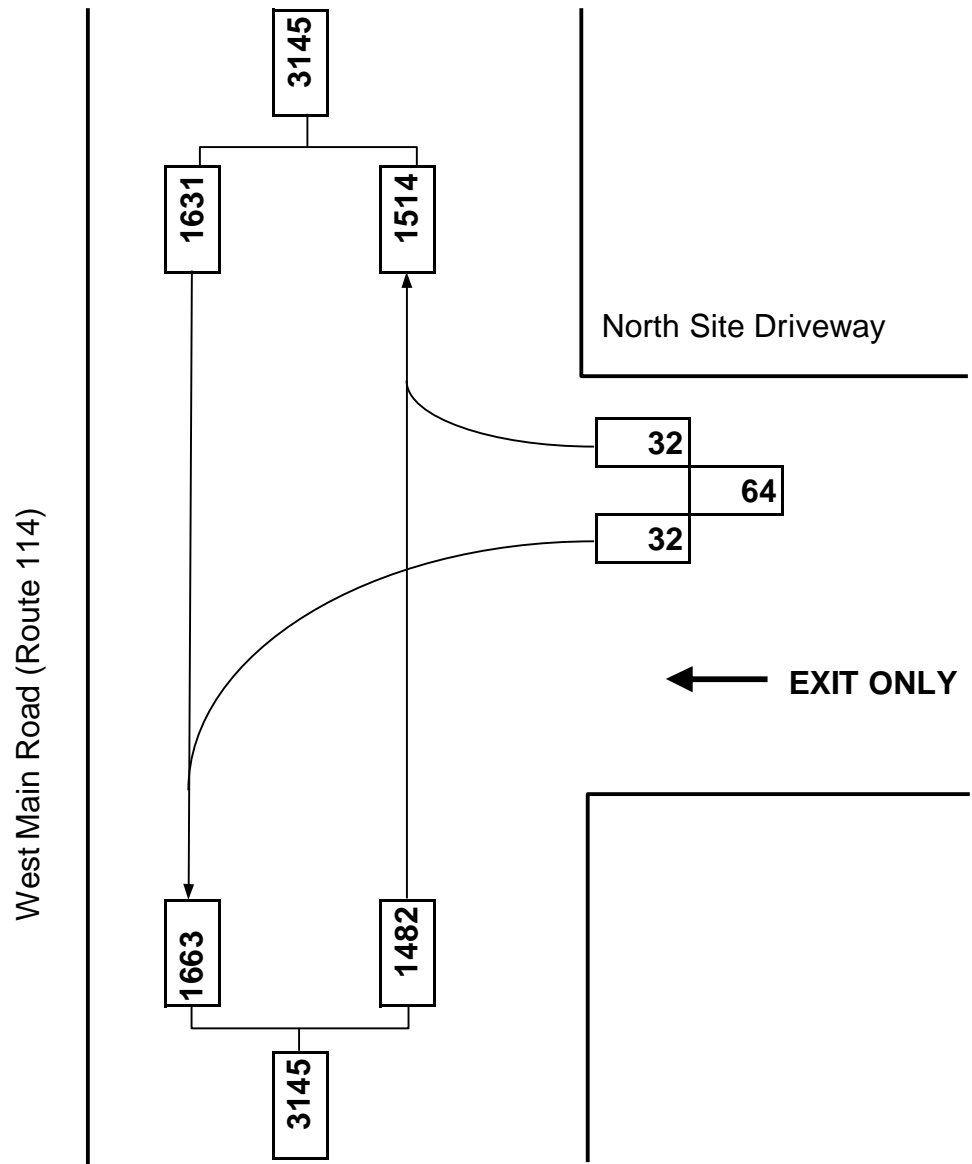

Intersection

Int Delay, s/veh 6.1

Movement	WBL	WBR	NBT	NBR	SBL	SBT
Lane Configurations	↘	↗	↕↕			↕↕
Traffic Vol, veh/h	32	32	1482	0	0	1631
Future Vol, veh/h	32	32	1482	0	0	1631
Conflicting Peds, #/hr	0	0	0	0	0	0
Sign Control	Stop	Stop	Free	Free	Free	Free
RT Channelized	-	None	-	None	-	None
Storage Length	0	0	-	-	-	-
Veh in Median Storage, #	0	-	0	-	-	0
Grade, %	0	-	0	-	-	0
Peak Hour Factor	92	92	92	92	92	92
Heavy Vehicles, %	0	0	2	0	0	2
Mvmt Flow	35	35	1611	0	0	1773

Major/Minor

	Minor1	Major1	Major2			
Conflicting Flow All	2498	806	0	-	-	-
Stage 1	1611	-	-	-	-	-
Stage 2	887	-	-	-	-	-
Critical Hdwy	6.8	6.9	-	-	-	-
Critical Hdwy Stg 1	5.8	-	-	-	-	-
Critical Hdwy Stg 2	5.8	-	-	-	-	-
Follow-up Hdwy	3.5	3.3	-	-	-	-
Pot Cap-1 Maneuver	~ 24	329	-	0	0	-
Stage 1	152	-	-	0	0	-
Stage 2	368	-	-	0	0	-
Platoon blocked, %			-			-
Mov Cap-1 Maneuver	~ 24	329	-	-	-	-
Mov Cap-2 Maneuver	~ 24	-	-	-	-	-
Stage 1	152	-	-	-	-	-
Stage 2	368	-	-	-	-	-

Approach

	WB	NB	SB
HCM Control Delay, s	\$ 301	0	0
HCM LOS	F		

Minor Lane/Major Mvmt

	NBTWBLn1	WBLn2	SBT
Capacity (veh/h)	-	24 329	-
HCM Lane V/C Ratio	-	1.449 0.106	-
HCM Control Delay (s)	-	\$ 584.8 17.2	-
HCM Lane LOS	-	F C	-
HCM 95th %tile Q(veh)	-	4.3 0.4	-

Notes

-: Volume exceeds capacity \$: Delay exceeds 300s +: Computation Not Defined *: All major volume in platoon